

Italian National Agency for New Technologies,
Energy and Sustainable Economic Development



VTT Technical Research Centre of Finland Ltd

DOSSIER

THE YELLOW PAGES OF SOFC TECHNOLOGY

International Status of SOFC deployment
2017

Stephen J. McPhail, Jari Kiviaho, Bruno Conti



IEA

Implementing Agreement *Advanced Fuel Cells*
Annex 32 – SOFC

THE YELLOW PAGES OF SOFC TECHNOLOGY
International Status of SOFC deployment 2017

IEA
Implementing Agreement *Advanced Fuel Cells*
Annex 32 – SOFC

THE YELLOW PAGES OF SOFC TECHNOLOGY
International Status of SOFC deployment 2017

IEA - Implementing Agreement *Advanced Fuel Cells*
Annex 32 – SOFC

Authors: Stephen J. McPhail, Jari Kiviaho & Bruno Conti

Publisher: VTT Technical Research Centre of Finland Ltd, P.O. Box 1000, 02044 VTT, Finland

ISBN 978-951-38-8602-8 (printed); ISBN 978-951-38-8603-5 (online)

Printed by Juvenes Print, Helsinki, Finland, 2017

TABLE OF CONTENTS

THE SOFC BASIC PRINCIPLES.....	4
High efficiency	4
Fuel flexibility.....	5
Insignificant emissions	5
Silent operation	5
How it works.....	6
APPLICATION AREAS.....	7
Mobile, military and strategic.....	7
Auxiliary Power Units (APU) (1–250 kW)	8
Stationary small scale combined heat and power (m-CHP).....	10
Stationary medium-large scale.....	11
A WORLD INDUSTRY: Overview of worldwide SOFC developers	12
North America	12
Atrex Energy	12
Bloom Energy	13
Ceramatec.....	14
Delphi.....	15
FuelCell Energy.....	16
LG Fuel Cell Systems (LGFCs).....	17
Materials and systems Research, Inc. (MSRI).....	18
Protonex	19
Ultra USSI.....	20
Nexceris	21
Europe.....	23
Adelan.....	23
Bosch Thermotechnology.....	23
Ceres Power.....	24
Convion Ltd.....	25
Elcogen.....	27
ElringKlinger AG.....	28
Haldor Topsøe AS.....	29
Kerafol GmbH.....	30
Hexis/Viesmann.....	30
mPower GmbH.....	31
New enerday GmbH.....	32
Plansee SE.....	33
SOLIDpower SpA.....	34
Sunfire-Staxera	35
Zegpower	36
Asia	38
Aisin Seiki	38
Chaozhou Three-Circle Co., Ltd. (CCTC).....	39
G-cell Technology Co., LTD	40
Gas Authority of India Ltd./Bloom Energy	41
h2e Power Systems Inc.....	41
Huatsing Jingkun New Energy Technology Co., Ltd.....	42
Mitsubishi-Hitachi Heavy Industries (MHI)	43
MiCo.....	45
POSCO Energy.....	45
SOFCMAN Energy Technology Co., Ltd.	46
Contact List for SOFC Deployment	47

THE SOFC BASIC PRINCIPLES

Solid oxide fuel cells (SOFC) are a cutting-edge technology for converting the chemical energy in hydrocarbon fuels to electrical power and heat by means of an electrochemical reaction. SOFC technology has many advantages over conventional power trains, such as combustion engines, including:

- high efficiency, including at small scale
- fuel flexibility
- insignificant NO_x, SO_x and particulate emissions, reduced CO₂ emissions
- silent and vibration-free operation.

High efficiency

The SOFC differs from conventional technologies such as combustion engines and gas turbines in that it converts the chemical energy of fuels *electrochemically*, generating electrical power directly, avoiding the inefficient steps of combustion and transformation of heat to mechanical work in order to drive the electrical generator.

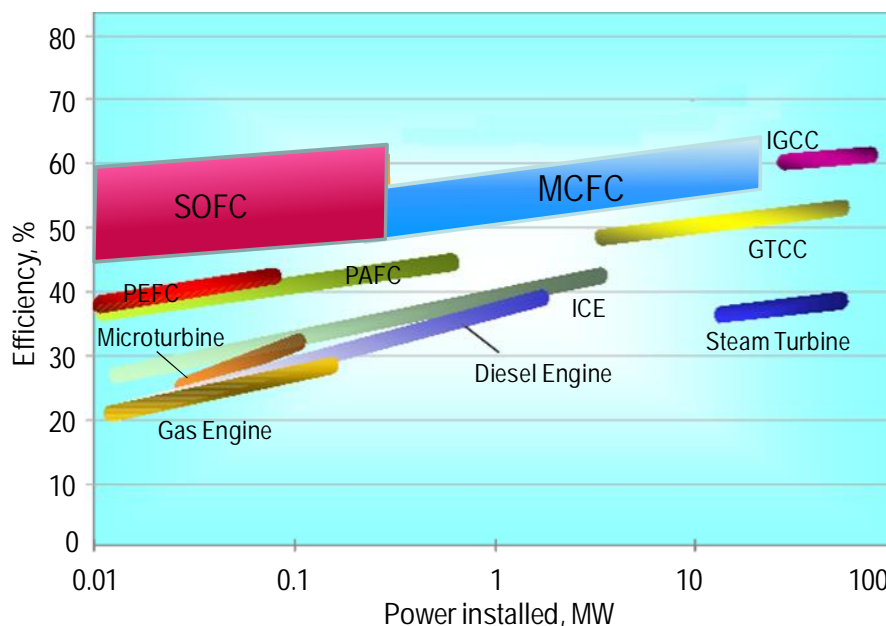

Figure 1. Comparison of combustion-based system and fuel cell efficiencies vs. power installed (ICE = internal combustion engine, GTCC = gas-steam turbine combined cycle, IGCC = integrated gasification combined cycle, PEFC = polymer electrolyte fuel cell, PAFC = phosphoric acid fuel cell, MCFC = molten carbonate fuel cell, SOFC = solid oxide fuel cell, SOFC-GT = SOFC and gas turbine bottoming cycle) [source: ENEA, www.enea.it]

Ideally, the power produced in an SOFC can reach up to 70% of the inlet fuel energy; in practice, within an end-user-ready system, these efficiencies are between 40–60%, depending on the power plant configuration. Combustion-based technologies can only reach 55% electrical efficiency in very large-scale power plants (of hundreds or thousands of Megawatts). The SOFC efficiency is unique in being practically independent of scale, and systems have been demonstrated with 60% net efficiency even at one kilowatt of delivered power.

Fuel flexibility

Thanks to the SOFC's high operating temperature (600–900 °C), low molecular weight hydrocarbons can be internally reformed, without the need for an external reformer. With appropriate conditioning, in order to remove harmful contaminants and to ensure a proper balance of the specific carbon compounds, such diverse fuels can be utilized as natural gas, biogas, ethanol, methanol, propane, LPG (liquefied petroleum gas) and even diesel and jet fuel.

Alternative carbon-free liquid fuels such as ammonia and hydrazine can also be utilized in SOFCs, even though the use of the latter remains limited due to its high production cost. Ammonia, used to great extent in industry for the synthesis of fertilizers and explosives, presents the advantages of being low-cost, simple to store, containing high energy density without production of carbon dioxide.

Insignificant emissions

By avoiding a combustion process to convert fuel to electricity, the SOFC does not produce nitrous oxides (NO_x) or fine particulate matter. Furthermore, because sulphur compounds are poisonous for the fuel cell, they need to be extracted from the fuel beforehand to ensure reliable operation, therefore sulphurous oxide (SO_x) emissions are insignificant. In this way it is also guaranteed that no harmful compounds are released into the environment, shifting the onus of emission control onto the fuel supplier, where it can be handled efficiently and centrally.

Thanks to the SOFC's high efficiency, for a given amount of power produced less primary fuel is required, which means less CO₂ is emitted to the atmosphere. If the fuel is obtained from renewable sources, such as biogas, the operation of the SOFC is effectively carbon-neutral, and ultra-clean.

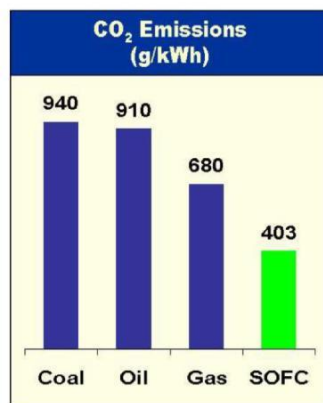

Figure 2. Comparison of CO₂ emissions between combustion-based systems and a natural gas-fed SOFC [source: Acumentrics, www.acumentrics.com]

Silent operation

Electrochemical conversion of the fuel forgoes the need for moving parts for power generation, which means an SOFC system runs essentially vibration- and noise-free: a desirable characteristic both in open spaces and closed areas.

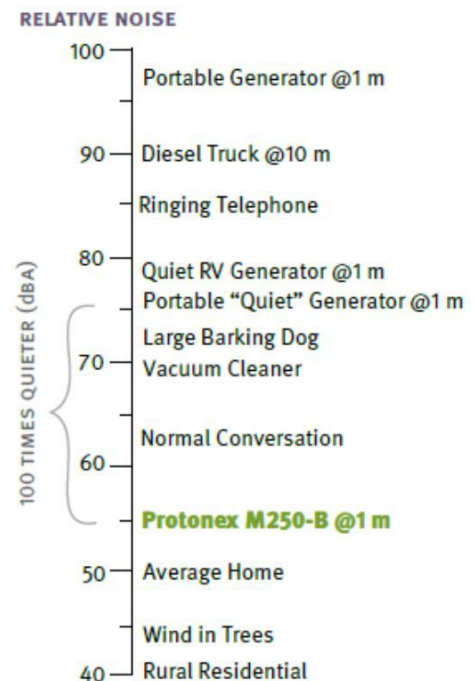

Figure 3. Noise and vibration emissions from a small FC system allow you to hear yourself speak [source: Protonex, www.protonex.com]

How it works

In Figure 4 below, the building block of the SOFC is shown: each of these cells – consisting of an anode, electrolyte and cathode – can be connected and stacked up to provide any requirement of power. This modular build-up is what makes it possible for the SOFC to have practically constant efficiencies from Megawatt to single watt scale.

The fuel is fed to the anode side, where the high temperature allows it to be separated into its essential constituents. In hydrocarbons, these are hydrogen (H₂) and carbon monoxide (CO). H₂ and CO react in the same way at the anode. Taking H₂ as an example, it reacts electrochemically to generate two electrons per molecule of hydrogen. This current is made to flow across the electrical load that needs to be powered, and reacts at the cathode side with the air – or the oxygen (O₂) in particular – that is fed there. Every two electrons generate an oxygen ion (O²⁻), which migrates across the gas-tight electrolyte to the anode, where it reacts with the hydrogen to release again the two electrons that generated the O²⁻ ion, effectively closing the circuit. In the process, the only by-product formed is water. In the case of CO, the by-product is CO₂. The outlet of the SOFC therefore produces a clean and relatively pure mixture of water and carbon dioxide. Thus, if necessary, the carbon dioxide can be separated and sequestered much more easily than is the case with the by-product flows from combustion, where large quantities of nitrogen, contained in the air used for combustion, dilute the CO₂ content and make it energy- and cost-intensive to separate. Furthermore, the potential to generate clean water could make them attractive for areas and applications where water is in short supply.

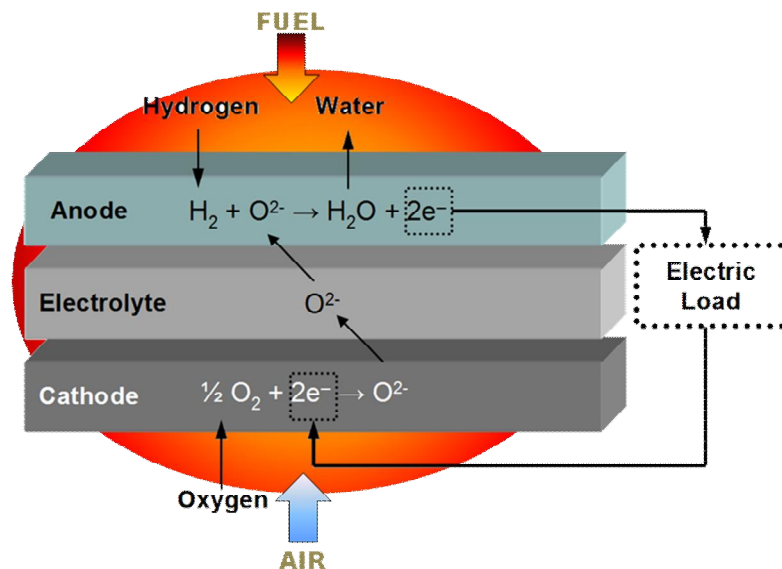

Figure 4. How the SOFC generates high-efficiency power and heat from fuel and air

To turn the stack of cells to a fully functional power generating system several auxiliary components (the so-called balance-of-plant, BOP) have to be integrated, taking care of fuel pre-treatment, power management and heat exchange.

In order to preserve the high efficiency of electrochemical conversion in the SOFC, the BOP often needs to be designed and produced specifically to optimize the integration and minimize parasitic losses. This is an important part of turning the SOFC to real, viable end-products.

APPLICATION AREAS

Since SOFC systems can be built to any scale between several watts up to several hundreds of kilowatts, they can serve a large variety of applications, maintaining their properties of fuel flexibility and high electrical efficiency. In particular, the most promising areas for their immediate utilization are:

- Mobile, military and strategic (<1 kW)
- Auxiliary Power Units (APU) and back-up power (1–250 kW)
- Stationary small-scale combined heat and power (m-CHP) (1–5 kW)
- Stationary medium-large scale (0.1–10 MW).

For each of these fields of applications, there are already pioneering industrial developers attempting to enter the market, gaining valuable experience and expertise in terms of practical know-how and end-user requirements. This front-line activity is highly necessary in order to make up the lag between the SOFC and the conventional technologies utilized in these areas, especially in terms of robustness, cost and familiarity with consumers. That is why for each of the application areas mentioned, a brief overview will be given of the current suppliers of end-user-ready systems.

Mobile, military and strategic

One of today's major concerns in the energy field is to fulfil the harsh requirements for mobile applications (<1 kW), especially in the field of military defence and strategic reconnaissance. Above all reduced weight and volume with high power densities, as well as robustness, are the requested characteristics.



Figure 5. *The iRobot PackBot UGV AM is a reconnaissance unmanned system, capable of 12 hours autonomy covering about 40 miles of terrain. This System is hybridized with a standard battery for 2.5 hours (8 miles) extra autonomy [source: Ultra-AMI, Proceeding of Fuel Cell Seminar and Exposition 2011]*

The portable electronics market represents a niche market for solid oxide fuel cell micro-systems. State of the art Li-ion and Ni-ion rechargeable batteries and the PEMFC have significantly lower energy densities than the SOFC. More powerful hand-held electronic devices such as mobile phones or laptops could be used uninterruptedly for weeks fuelling the micro-unit with a small fuel cartridge.

Fuel consumption in military defence applications represents an enormous economic cost to Defence departments, and thus to the taxpayers. Currently, power generator sets (*gensets*) are the largest consumers of fuel on the battlefield, making the transport of fuel to be an army's Achilles' heel. SOFC systems not only offer up to 85% fuel savings when compared to traditional diesel electricity generators, but can run on a variety of fuels. The silent operation of the fuel cell technology is an inherent advantage for strategic operations and the generation of water as a by-product makes the unit even more valuable as it could be a source of clean water supply for soldiers.

In the civilian field there is a vast number of telecommunication systems located in isolated regions, far away from the natural gas grid or electricity network, which are powered by traditional inefficient stand-alone gensets. SOFC technology fits like a glove for supplying clean, reliable and efficient energy to the telecommunications' network. Another industry that could certainly take advantage of these characteristics is the gas & oil industry. Apart from providing more efficient power off-shore, SOFC systems can be used for cathodic protection of gas pipelines to prevent corrosion, substituting the devices used today, which have an extremely low efficiency.

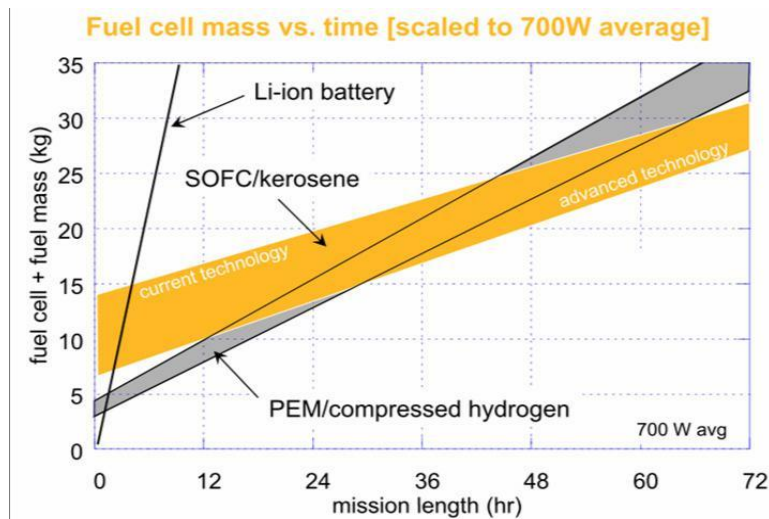

Figure 6. Device weight as a function of autonomy for 3 portable power solutions [source: Protonex, Proceeding of Fuel Cell Seminar 2009]

Industrial Developers Mobile, Military & Strategic:
Ultra Electronics AMI, Lockheed Martin, Protonex

Auxiliary Power Units (APU) (1–250 kW)

SOFCs can also be employed in auxiliary power units (APU) for on-board generation of electricity on vehicles of any kind. The main scope for application is that of electricity supply while a vehicle is at a standstill, ranging from caravans stationed overnight to aircraft parked at an airport gate. An SOFC-based APU also improves electricity generation efficiency during the vehicles' journeys and can supply back-up power during emergencies.

Many large vehicles run on diesel today, and SOFCs offers the advantage of being able to operate on diesel reformat without the necessity of further gas processing steps that would be required to purify the reformat to hydrogen. It is the ideal APU unit from a size of 500 We1 (watts electric power) up to several tens of kWel for road vehicles or even several hundreds of kWel as required by aircraft and marine vessels.



Figure 7. A demonstration model of the Delphi APU on-board of a commercial truck [sources: Delphi, Proceedings of Fuel Cell Seminar 2011 and DoE Peer Review 2012]

The efficiency of electricity generation on board of vehicles, using a conventional generator coupled to the engine, is in the range of 10 to 15% today. The system net efficiency of an SOFC APU could reach above 30%, which would more than double the power yield from the same amount of fuel. Additionally, on-site emission of diesel fumes, noise, and other pollutants would be reduced to near-zero. Utilization of the heat produced by the SOFC for heating or cooling (via absorption coolers, for instance) on the vehicles would further increase the overall efficiency.

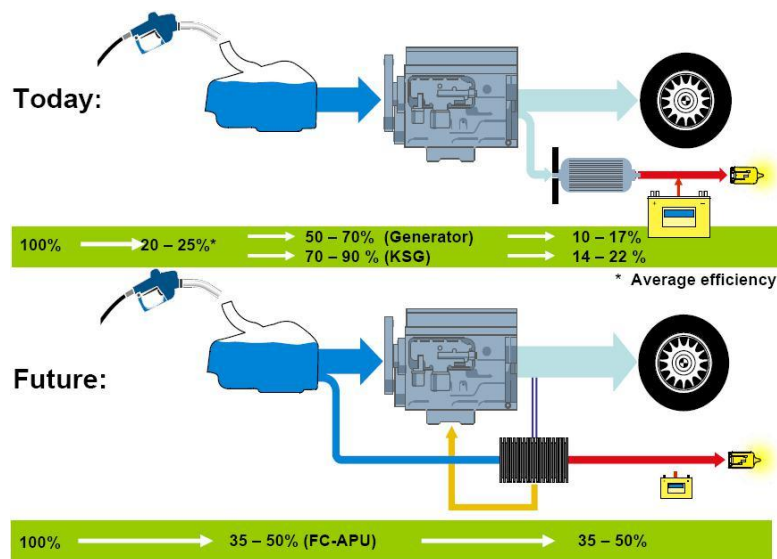

Figure 8. Comparison of overall electric efficiency between a conventional engine-based power train (fuel-engine-generator-load) and a SOFC-based APU (fuel-SOFC-load) [source: BMW, courtesy of Forschungs Zentrum Jülich]

Industrial Developers Auxiliary Power Units (APU):
 Delphi, Protonex, Ultra Electronics AMI, New Enerday

Stationary small scale combined heat and power (m-CHP)

Stationary small scale power plants (1–5 kW) are usually referred to as micro-CHP, which stands for residential-scale combined heat and power.

The great potential of this application lays in the fact that both power and heat for a household can be generated on the premises, from a single primary energy carrier, such as natural gas or LPG. This obviates transportation losses and greatly enhances the utilization of these fuels, reducing waste. Each end-user thus becomes a producer as well, creating the opportunity to sell electricity when supply exceeds the household's demand. This concept is known as distributed, or decentralized, generation and is explained in the following figure.

As can be seen, considerable amounts of primary energy input can be saved by producing power on the spot and utilizing the excess heat for heating purposes, rather than relying on centralized production of power and separate heat generation.

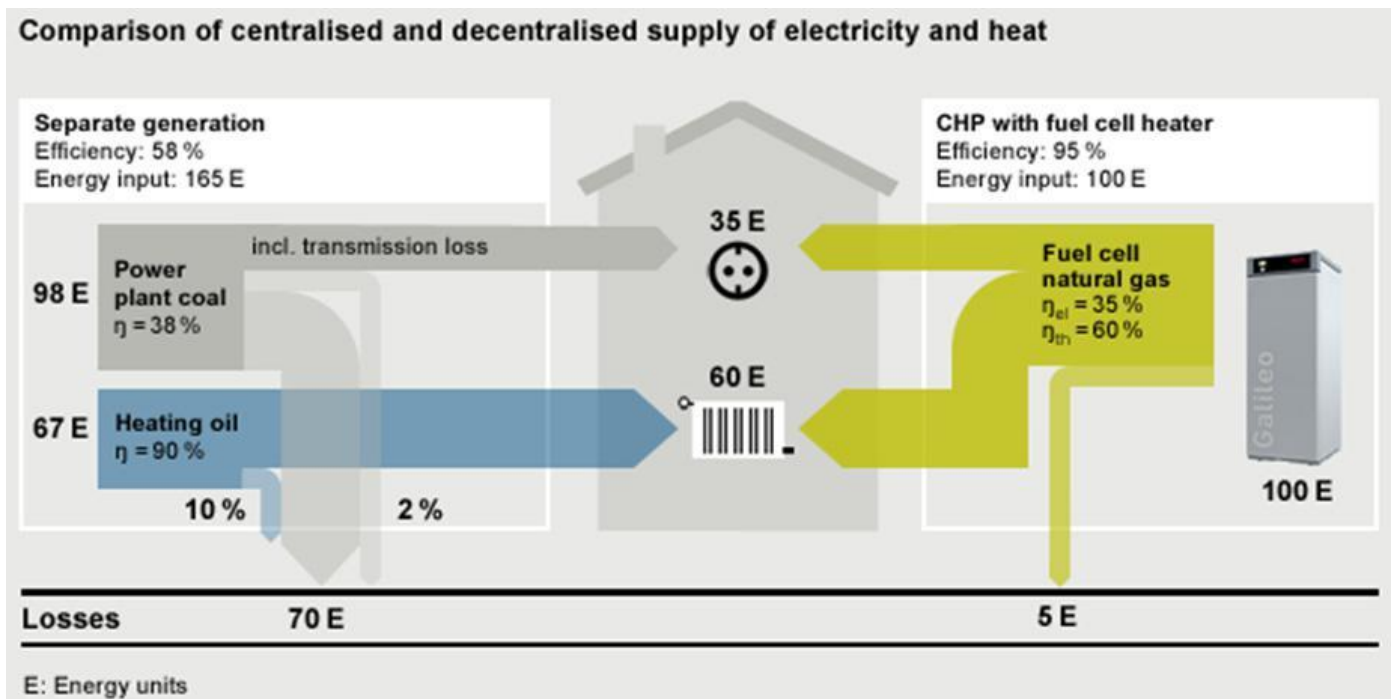

Figure 9. Comparison of overall primary energy consumption between centralized supply or on-the-spot micro-CHP, for given household power and heat requirements [source: Hexis AG, www.hexis.com]

Two main modalities can be distinguished of micro-CHP systems: those that obtain the fuel from the grid (e.g. natural gas) and those that work isolated from the grid (off-grid or stand-alone) thus having to store the fuel.

Thanks to the widespread availability of natural gas through the distribution grid, the grid-connected application has the potential to become very widespread, and the potential market – aiming in particular at the replacement of old household boilers – could be of several hundreds of thousands of systems per year in Europe alone.

Industrial Developers Stationary Small-Scale CHP:

Acumentrics, Ceres Power, Ceramic Fuel Cells, Elcogen, Hexis, Kyocera, SOFCpower, Staxera-Sunfire, Topsøe Fuel Cells

Stationary medium-large scale

Electricity can be transported over long distances with little power loss, but heat cannot be piped efficiently far from the point of generation. In order to make use of the generated heat, power plants should therefore be smaller, dispersed and located nearby the end-users. However, conventional power plants cannot be down-scaled without efficiency loss, and also the negative impact of a combustion-based plant is generally not desirable in the vicinity of the end-user basin. Medium and large SOFC-based generation systems (in the range of hundreds and thousands of kilowatts) do not have these drawbacks and can efficiently combine heat and power delivery at “neighbourhood scale”, as well as to other centres that can benefit from having their own, independent power and heat supply.

Medium-scale SOFC generation can also fit the needs of the automotive industry for clean and efficient powering, either by integrating the unit inside the vehicle (see the section on Auxiliary Power Units), or by externally recharging battery electric vehicles (BEV). The transportation sector represents the fastest-growing sector in terms of energy consumption, with a vast majority of greenhouse gas emissions being produced by road-based transport. Battery-recharging stations installed strategically in areas isolated from the electricity grid could contribute to improve the infrastructure and promote the use of electric vehicles, thereby reducing local CO₂ emissions and overall fuel consumption.

Though smaller systems limit the liability of SOFC products in the early stages of market introduction, and are therefore favoured by industry today, large-scale SOFC plants certainly represent the next step in providing clean affordable energy to society at large. At multi-megawatt scale, traditional powering technologies can be integrated into fuel cell-based power plants to achieve even higher electrical efficiencies, for example by incorporating a bottoming cycle with gas and/or steam turbines working either under atmospheric or pressurized conditions. Integrated gasification fuel cell power plants (IGFC) become economically feasible with large-sizes, as the efficiency of turbines increases with their size.

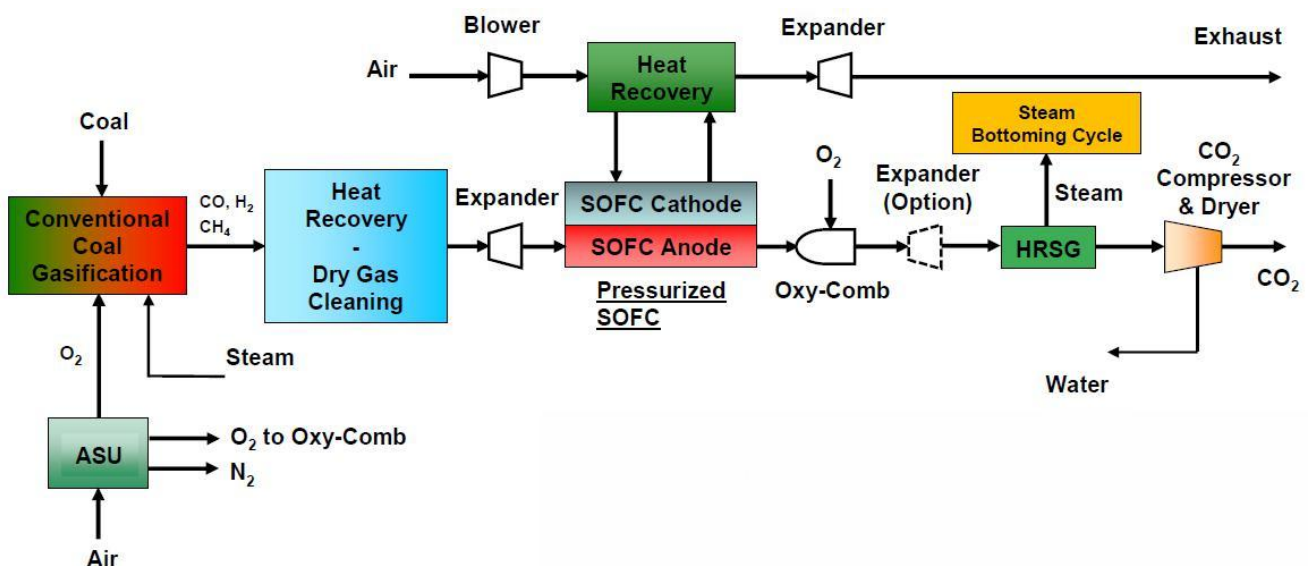

Figure 10. SECA Coal-Based Systems Pressurized IGFC (conventional coal gasification, low water use, 99% carbon capture, 50% efficiency) [source: NETL, Proceedings of International Energy Agency (IEA) 2011 – Annex 24, Solid Oxide Fuel Cells]

Industrial developers Stationary Medium-Large Scale:

Bloom Energy, Delphi, Mitsubishi Heavy Industries, LG Fuel Cell Systems, Versa Power Systems

A WORLD INDUSTRY: Overview of worldwide SOFC developers

North America

Atrex Energy

began as the advanced Research and Development division of Acumentrics Corporation, a manufacturer of highly reliable power products. These include rugged, uninterruptible power supplies for use in harsh environments. Founded in 1994, Acumentrics created the R&D division in 1999 to help develop both a compact energy storage device based on a rapidly spinning flywheel and a unique fuel cell unlike any others at the time. With the growing market success of the remote power products, in 2015 Atrex Energy was formed as an independent, stand-alone company. The goal of Atrex Energy is to continue to expand the SOFC portfolio as well as develop and commercialize new power and energy products. Since 2000 Atrex Energy has spent over \$100 million on the research and development of a commercially viable Remote Power Generator utilizing SOFC. Atrex Energy has made substantial progress in improving the technology over this timeframe:

- Increasing the output per fuel cell tube 120-fold
- Developing SOFC designs with peak output over 10 kW; the first working SOFC generated a mere 20 watts of power
- Tripling power density
- Developing 15 patented innovations

A key design feature of the Atrex Energy SOFC design is the actual tubular shape of the fuel cell. The patented tubular design eliminates one of the biggest issues facing fuel cell technology – catastrophic damage due to temperature gradients. Temperature gradients occur during the normal thermal cycling that takes place during start-up, shut down and load changes. This cycling, over the lifetime of the unit, introduces stresses that could eventually manifest into cracks and ultimately failure. The small radius geometry of Atrex Energy's tubes, their inherent strength, the strong seal at one end and the operation under low pressure combine to minimize temperature gradients. This allows the tubes to easily tolerate thermal cycling. In addition, Atrex Energy's tubular design is much more tolerant to the stresses from internal reforming. So the need for costly external reformers common with planar fuel cell systems is eliminated. In fuel cells using planar ceramic plates there is an inherent weakness in the plates. They are fragile and hard to seal. Once assembled in stacks they require air and fuel to be supplied under high pressure. As a result, the plates can be prone to breaking under thermal stress. Internal reforming of fuel is also destructive to planar or membrane fuel cells due to the temperature gradients resulting from the reforming process. This makes external reforming a necessity even for simple fuels, adding cost and complexity to the operation. It is also less efficient at reforming the fuel than the internal method used in Atrex Energy's SOFC design.

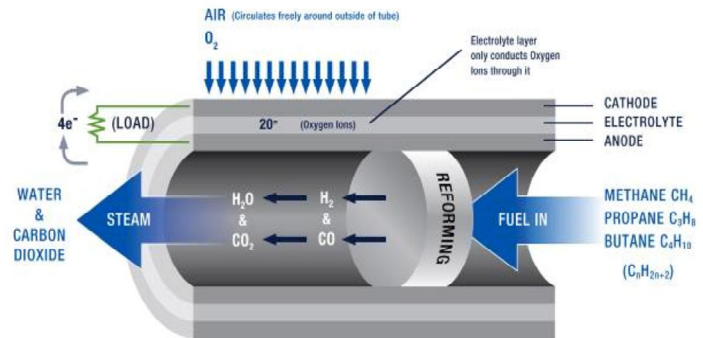

Figure 11. The Atrex Energy SOFC tubular design, and operating principle

The Atrex Energy Remote Power Generator System has been designed to provide users with the most flexibility possible to meet a wide range of customer needs. Atrex Energy can work with users to configure the power generator to optimize the performance for each application. Some of the key attributes that can be configured:

- Power Output: Four different models handling loads of 100 watts up to 4500 watts
- Voltage range: Output voltage from 2 VDC up to 60 VDC
- Fuel Flexibility: Propane or Natural Gas
- Electrical modes: three electrical operating mode options – constant current, constant voltage or battery charge
- System data interface to a customer-provided SCADA system
- Remote Current Interrupt (RCI) capabilities with customer-provided Remote Monitoring Unit (RMU)
- 12VDC or 24VDC Auxiliary Output option.



Figure 12. The Atrex Energy RP250

Bloom Energy

was founded in 2001 with the name Ion America and based in California (USA). The company changed its name to Bloom Energy (BE) few years later, following major investments.

Bloom Energy develops and commercializes large reliable SOFC systems with high efficiencies. At the core of their products are stacks of planar electrolyte-supported fuel cells manufactured with noble metals sprayed on ceramic supports that require no special inks. Part of the technology adopted was already developed through their work as a partner in NASA's Mars Program.

In cooperation with the University of Tennessee (USA), BE produced a 5 kW_{el} stack which was tested in field trials starting in 2006 in places with diverse climatology, including California, Alaska and Tennessee. In the period ranging from November 2006 to December 2009, in cooperation with the U.S. Department of Energy (DoE), R&D activities were directed towards a 25 kW_{el} grid-connected system for co-production of electricity and hydrogen. The field-tested units worked for more than 5000 hours and the availability of the plants was over 97%. The company has continued increasing the

size of their systems during these last years, producing the servers: ES-5000, ES-5400 and ES-5700, generating 100, 105 and 210 kW_{el} respectively.

The heart of these servers is built up with 1kW_{el} stacks, labelled as 'Bloom Boxes', which are composed of 40 cells of 25W_{el} each, fuelled with natural gas or biogas and achieving over 50% net electrical efficiency.

A number of renowned multinationals have chosen to install Bloom Energy's servers to power their headquarters, the vast majority of these are in California. As an example, Google, Coca-Cola, Ebay, Walmart and Bank of America are amongst their clients. Each Energy Server can be connected, remotely managed and monitored by Bloom Energy, this way minimizing possible failures. The system can be fuelled by natural gas or biogas, in grid-connected or stand-alone configuration, ensuring continuous supply of energy, with high electrical efficiency even at part loads.

The Uninterruptible Power Module (UPM) allows Bloom Energy Servers to supply constant, stable power to protected loads during grid outages or grid flicker events. It is a modular addition to the Bloom Energy Server platform that enables delivery of high quality, grid-independent power for business and operational continuity.

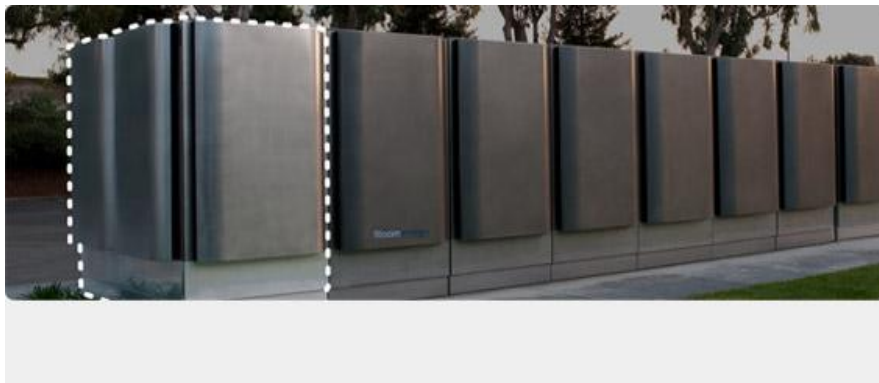

Figure 13. UPM-570 Uninterruptible Power Module with a nameplate power output of 160 kW [source: www.bloomenergy.com]

Ceramatec

is an advanced ceramics material technologies research and development company that provides solutions to difficult scientific challenges facing companies, governments and research institutions worldwide. A CoorsTek company established in Utah (U.S.A.), Ceramatec is a key competency center of its global research and development organization, focused primarily on applications in the energy and environment sectors. Ceramatec has pioneered research and development in a variety of technologies based on ceramic solid-state ionics and electrochemical systems such as oxygen sensors, oxygen production, chemical production, and solid oxide fuel cells. CoorsTek is the partner of choice for technology & manufacturing companies worldwide, whose success requires the unique, high-performance properties of products manufactured from engineered ceramics & advanced materials. They deliver outstanding value through:

- Operational excellence
- Broad research, development, and manufacturing capabilities
- Unsurpassed expertise in materials engineering
- Highly collaborative, responsive, and reliable relationships



Figure 14. Ceramatec's anode supported single cells and stack [source: www.Ceramatec.com]

Ceramatec is exploring several different solutions in the area of renewable energy storage. Ceramatec has more than two decades of experience in developing and testing Solid Oxide Fuel Cell systems. KW size stacks have been tested using a variety of fuels such as natural gas, reformed JP-8, etc. Electrolyte materials investigated include oxygen ion conducting stabilized zirconia, doped ceria, and doped lanthanum gallate and proton conducting doped barium cerate.

Delphi

is a leader in electronics for automotive technologies. The company has created solid oxide fuel cell units for over a decade, focusing their R&D towards powering vehicles, stationary power generation and military applications.

As a result of its fuel flexibility, the Delphi SOFC can be engineered to operate with many types of fuels including natural gas, diesel, bio-diesel, propane, gasoline, coal-derived fuel and military logistics fuel. It will also be able to use tomorrow's next generation fuels. Delphi began work on solid oxide fuel cells in 1998 and has been a leader in the technology ever since. Delphi is the only member of the U.S. Fuel Cell Council that has developed and demonstrated a practical, operational SOFC auxiliary power unit (APU) for heavy duty commercial trucks. Delphi has partnered with private industry and leading academic institutions in the development of solid oxide fuel cell technology and has received funding from the U. S. Department of Energy and the U. S. Department of Defense for fuel cell development. A single Delphi Gen 4 SOFC Stack can provide 9 kW of electrical power and it features a modular design, ideal for integration into large power plants.

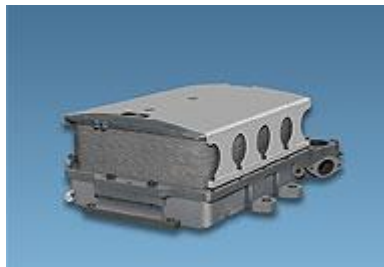

Figure 15. Delphi SOFC stack [source: www.delphi.com]

Delphi develops rectangular robust anode-supported cells. Generation-4 is their latest product in which the anode, cathode and electrolyte are based on nickel oxide yttria-stabilized zirconia, yttria-stabilized zirconia (YSZ) and Strontium-Cobalt-Lanthanum-Ferrite (LSCF) with Ceria-based interlayer respectively. Generation-4 stacks have 403 cm² of active area, providing high quality and reliable power (110 VAC and/or 12 VDC), with electrical efficiencies ranging from 40 to 50%. This stack is less

expensive than Generation-3 thanks to improved interconnects and coatings and the pack's increased power (5 kW). The system can be run on several fuels including natural gas, diesel, bio-diesel, propane, gasoline and coal-syngas.

In cooperation with Volvo Trucks North America (VTNA) Delphi has developed a backup system suitable for heavy duty trucks and recreational vehicles. This APU allows shut-off of the main engine during long-term parking and full use of the cabin services, saving up to 85% of the fuel currently required for a main diesel engine running idle. It is the only member of the United States Fuel Cell Council that has developed and demonstrated in practice an SOFC power unit for heavy commercial vehicles.

FuelCell Energy

A world-leading developer of molten carbonate fuel cell (MCFC) systems, it absorbed Canadian Versa Power progressively from 2004 taking over and furthering their SOFC technology. In this way FuelCell Energy (FCE) brought their knowledge of fuel cell system deployment, especially related to multi-megawatt power plants for urban heat and power supply, to value in the smaller power scales targeted by SOFC. SOFC development facilities are divided between Calgary (CAN) and Danbury (CT).



Figure 16. Baseline FCE/Versa SOFC stack building block: Cell size 25x25 cm², 120 cells, 68% fuel utilization, 25-70% in-stack reforming, around 16 kW gross DC electrical power [source: www.netl.doe.gov]

FCE have incorporated the SOFC components into fuel cell stacks as part of FCE's project under the U.S. Department of Energy Solid State Energy Conversion Alliance (SECA) program. The SECA program has a long term objective to introduce low-emission, high- efficiency SOFC based systems operating on coal gas in the size range of hundreds of megawatts. Other members of FCE's Coal-Based program team include the Gas Technology Institute (GTI), Pacific Northwest National Laboratory (PNNL), WorleyParsons Group, Inc., SatCon Power Systems, Inc., and Nexant, Inc.

The high efficiency and fuel flexibility of SOFC technology also makes it attractive for select portable power applications as FCE contracts with the U.S. Navy and a sub-contract to a U.S. Defense Advanced Research Projects Agency (DARPA) program illustrate. The U.S. Navy is evaluating the use of SOFC

power for propulsion and ship power of unmanned submarine applications as the virtual lack of emissions, high efficiency, and quiet operating nature are well suited for stealthy operations. DARPA is evaluating SOFC based systems for unmanned airborne applications. The DARPA airborne system is an example of SOFC technology deployed for energy storage. The complete system incorporates both SOFC and solar power generation. During the day, the solar power generation is used to power the aircraft and excess solar power generation is converted to hydrogen by the fuel cells as they operate in electrolysis mode. At night, the fuel cells run in fuel cell mode, converting the stored hydrogen to power. SOFC based energy storage systems have the potential to provide unprecedented round trip energy efficiency as the storage application of the technology is further developed.



Figure 17. Prototype large-scale SOFC combined heat and power module to be developed with [sources: Proceedings of SECA Workshops 2010 and 2012]

In terms of stationary heat and power generation, FCE has been awarded \$10M by the DOE for the design, fabrication, and testing of a 400 kilowatt (kW) prototype system comprised of two thermally self-sustaining atmospheric-pressure 200 kW Solid Oxide Fuel Cell (SOFC) power generators to be installed and operated at a prominent site. This work will demonstrate SOFC stack reliability and endurance and utilize FCE's SOFC system design philosophy based on factory-assembled stack building blocks, which may be used to fabricate larger multi-stack modules for both sub-megawatt (MW) and multi-MW systems applications. Ultimately, thirty-two baseline 120-cell SOFC stack blocks will be fabricated and integrated into four 100 kW modular power blocks (MPBs) for the 400 kW prototype system. The system design will include novel balance of plant (BOP) components and operational/control strategies to improve SOFC stack endurance and reliability. The project is due to conclude towards the end of 2017.

LG Fuel Cell Systems (LGFCs)

is part of the Korean multinational company LG. It acquired US Rolls Royce Fuel Cell Systems (RRFCS) in June 2012, investing \$ 45 million for the acquisition of 51% of RRFCS stock. According to the agreement, RRFCS now takes the name LGFCs. RRFCS was created in 1992 in the United Kingdom for the development of SOFC MW-size cogeneration systems. In 2007, RRFCS had acquired SOFCo-EFS, a US company engaged in the development of SOFC systems and fuel processing. The enterprise has offices in the UK, US and Singapore, and has actively participated in European and North-American public fundamental research programs, amongst which are the Large-SOFC project financed by the

European commission and the SECA Coal Based Systems and Coal Based SOFC Model Development Programme.

In 2008 they commenced the development of a hybrid pressurized SOFC- μ GT system, where 250 kW_{el} modules would be operated simultaneously obtaining power plants with nominal power higher than 1 MW_{el}. The ultimate goal of this project is to develop the suitable SOFC technology for use in integrated coal gasification plants with sizes greater than 100 MW, achieving an overall efficiency (considering the gasification of coal and CO₂ separation) higher than 50%.

LGFCs uses flat tubular cells in a segmented configuration where anode, electrolyte and cathode are repeated transversely and longitudinally on a porous ceramic support which, in operation, is crossed by the fuel while the oxidant laps the cathodic surfaces from the outer side, inside of a collector.

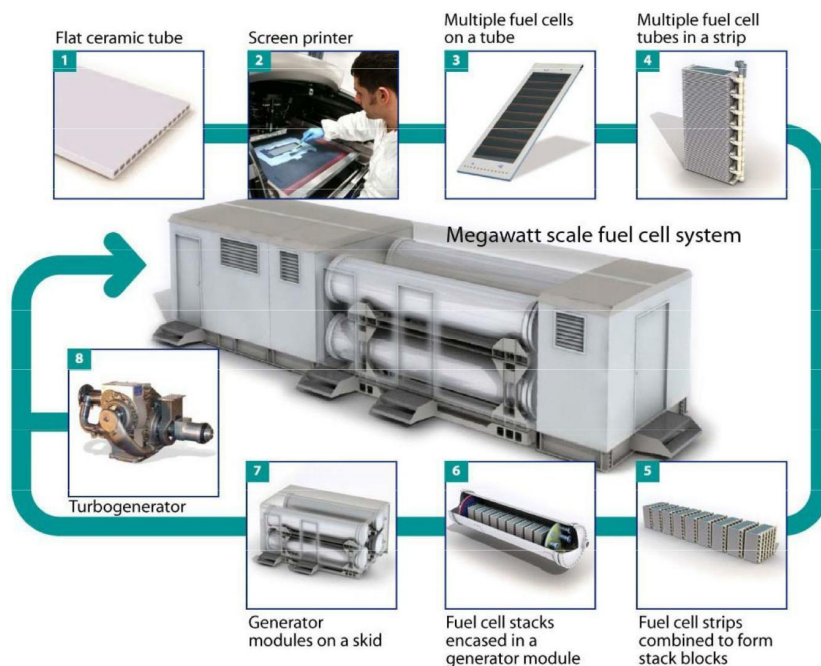

Figure 18. From component to final product: integration of RR-SOFC in the bundle, making up stacks, electrochemical modules and thermal units as base for multi-MW installations [sources: RRFCs, Proceedings of SECA Workshop 2010 and 2011]

Materials and systems Research, Inc. (MSRI)

was founded in 1990 by Dr. Dinesh K. Shetty and Dr. Anil V. Virkar. Since that time MSRI has expanded into a 10,000 square foot state-of-the-art research, testing, and production facility. MSRI's facilities include over 15 high-temperature furnaces, three ovens, a surface grinder, two tape casting machines, an isostatic press, a laminating press, and six fuel cell testing systems. MSRI is a world leader in materials research and development. Its expertise includes the following areas:

- Solid Oxide Fuel Cell (SOFC) Technology — Low emission, high efficiency electrochemical power generation
- Hydrogen Production Electrolyzer Technology — Small scale hydrogen production
- β "-alumina — Used in batteries and nuclear reactors
- Rechargeable Battery Technology — For high temperature applications
- Sensor Technology - Multi-species gas sensors
- Functionally Graded Si-C Technology — Will withstand a torque of 6,800 in. lbs.

MSRI has developed anode-supported fuel cells with very high power density amount of power measured in watts per square centimeter of surface area by optimizing the microstructure of composite electrodes. MSRI has demonstrated 1-3kW class SOFC power modules under various projects. Currently MSRI is developing a 3 kW air-independent SOFC stack for U.S. Navy's Unmanned Undersea Vehicles (UUV). This figure shows a 33-cell stack capable of delivering 1 kW of power at 800oC. The dimensions of the stack are 5.5" x 5.5" x 4.7" (W x L x H).

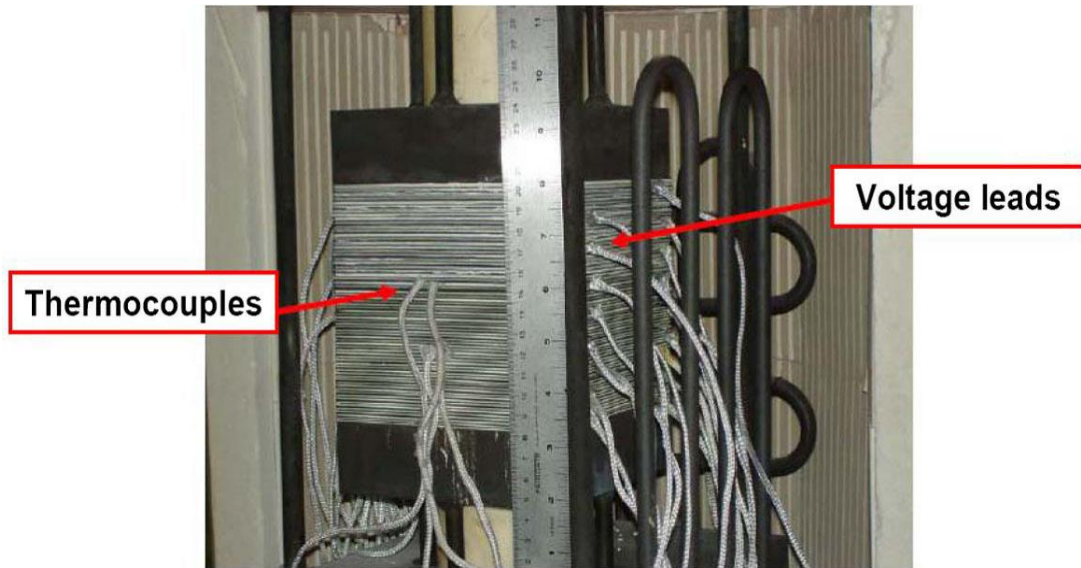

Figure 19. 1 kW 33-cell stack working at 800 °C [source: www.msri.com]

Anode-supported tubular design showed in *fig.* can be subjected to numerous thermal cycles and can be rapidly heated (e.g., within a couple of minutes) without cracking. No hot seal is needed.



Figure 20. 36-tube bundle for a 300 W portable power unit [source: www.Msri.com]

Protonex

was founded in 2000 with the aim of developing and marketing PEMFC units. In 2007 it acquired Mesoscopic Devices LLC, a company involved in the research and development of SOFC technology, fuel reforming, and desulphurization systems, which expanded its commercial interests to SOFC technology.

In the past, Mesoscopic Devices had built 'MesoGen-75' and 'MesoGen-250' portable systems, at 75 W and 250 W respectively, with funding from the Department of Defence and the U.S. Navy. These units were able to provide suitable power levels for radios, sensors, and small batteries; both versions could be fuelled by propane or kerosene. MesoGen-250 models were also designed to operate as a field battery charger, and as auxiliary and emergency units on military vehicles.

Protonex develops SOFC systems based on tubular-cell technology, compact and suitable to better guarantee the robustness required for portable and mobile applications. The SOFC products currently exhibited is the P200i.



Figure 21. Protonex P200i (20-200W) uses readily available commercial propane; made possible with an integrated sulfur filter [source: Protonex, www.protonex.com]

Based on Protonex's industry-leading Solid Oxide Fuel Cell (SOFC) technology, the P200i powers remote sensors, signaling, and communications systems in blistering heat and arctic cold, for months or years without human contact. Easily coupled with solar panels to minimize fuel usage, the P200i withstands the elements for far more cycles and operation hours than other SOFC systems, and uses inexpensive, easy-to-obtain propane for fuel. The P200i supports all common lead-acid and lithium battery chemistries, and has full hybridization support built-in, making integration fast and easy.

Ultra USSI

was established in 1993 in Ann Arbor. It is a successful international defence, security, transport and energy company. In 2011 Ultra Electronics Holdings acquired Adaptive Materials, an industrial developer of small SOFC systems using microtubular technology. Adaptive Materials was the first company to develop portable SOFC systems demonstrating their applicability in the field, since 2001 in collaboration with the U.S. Department of Defence. The company has developed, demonstrated and delivered successfully since then portable, affordable and fuel flexible SOFC systems, most of them to military customers and partners.

Ultra-USSI has a portfolio of compact, quiet and eco-friendly SOFC-based generation sets fed with propane to be utilized in the military, civilian and industrial sectors. The D300 (300W) model is suitable for applications as power support of on-field military power demand. The P250i (250W) is suitable for remote power supplies (boats or campers, to power GPS systems, radios, refrigerators) and emergency back-up power, and can also be fuelled with natural gas.

USSI delivered 45 units of the D300 adapted for unmanned air vehicles (UAV) for use by the U.S military in unmanned aerial systems. The D245XR (245 W) unit provides long duration flights of more than eight hours in small unmanned aerial vehicles, being much more suitable than conventional batteries.

All of the devices provide 12–24 DC Voltage power supply (to integrate with batteries, solar charge controllers, DC-DC converters, fused external communications, computers, modems, and other customer electronics), targeting robustness and light-weight, compromising on efficiency which stands at 20%.

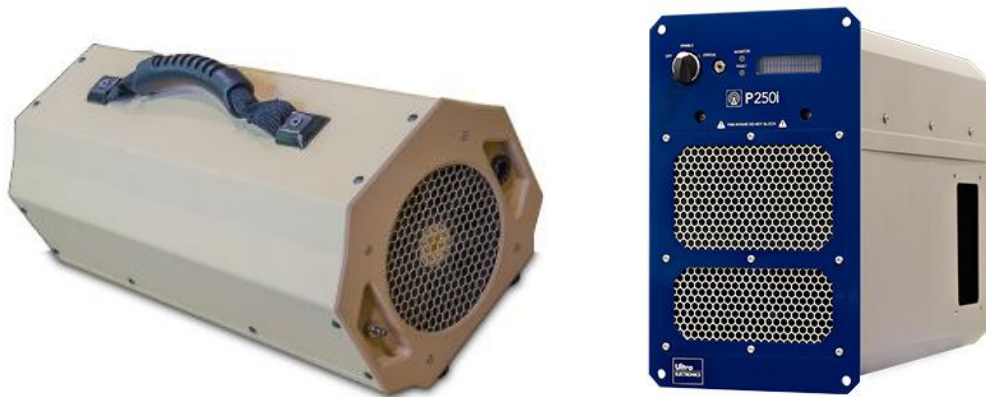

Figure 22. USSI D350 (245 W, 6"H x 16"L x 8"W, 5.1 kg, 134g/h propane) and P250 (250 W, 13"H x 17"L x 7"W, 10.7 kg, propane or natural gas-fuelled) [source: Ultra-USSI, www.ultra-fuelcells.com]

Nexceris

was founded in 1994. It is an American developer of advanced ceramics and electrochemical devices. Its commercial products are: SOFC materials and components, SOFC interconnect coatings and their products in the pipeline are SOFC stacks, based on their patented FlexCell components.

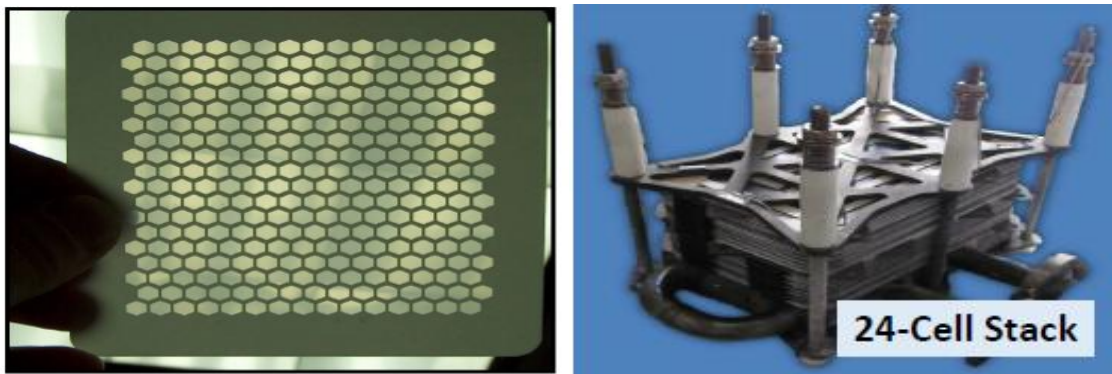

Figure 23. FlexCell (U.S. Patent No. 8,192,888) and Nexceris's 1 kW stack

The FlexCell has distinct characteristics:

- Thin electrolyte membrane for high performance
- Small repeat units for high gravimetric power density
- Dense electrolyte perimeter, enabling gasketed sealing
- Thin electrode to reduce gas diffusion limitations
- Sulfur tolerant anodes

These cells are integrated into SOFC stacks with the following features:

- Thin-foil interconnects: Crofer 22 APU with cathode-face coatings

- Seals: Ceramic/glass composites
- Shims: Alloys or inorganic materials
- Cathode current collectors: Silver mesh and coated metal alloy meshes
- Anode current collectors: nickel foam, coatings to preserve sulfur tolerance

Europe

Adelan

is a cleantech development company established in 1996 in United Kingdom, by Professor Kevin Kendall FRS and Dr Michaela Kendall.

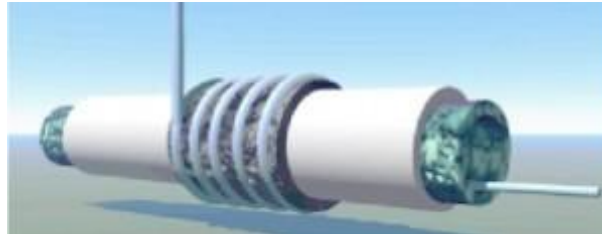

Figure 24. Adelan Microtubular SOFC [source: www.adelan.co.uk]

The Adelan team has the skills and capabilities to design, develop and implement micro-power solutions for a range of applications. Delivery of portable and mobile power solutions is Adelan's key strength. Adelan has more than three decades experience in SOFC material performance and degradation analysis, microtubular SOFC (m-SOFC) system design, and fuel cell demonstration. m-SOFC technology is developed and optimised by Adelan, with an aim to commercialise this technology in bespoke applications. Adelan technical skills are in the intellectual property related to m-SOFC systems, materials processing, SOFC testing and using various fuels, including hydrocarbons. Adelan produced many demonstrators over the years, including a m-CHP unit in 1997 and 2000. Adelan fuel cells are used in applications where power and heat are needed, typically in vehicles, buildings and remote areas. The energy is stored as liquid propane/butane or in methane as Natural Gas (NG) or Liquid Natural Gas (LNG). Electrical power is up to 250 W and heat is up to 1kW. Start-up time is good for solid oxide fuel cells, around 10–20 minutes, 3000 hours of operation and 100 cycles at this performance level can be readily achieved. The benefits include light weight compared to batteries and low maintenance costs. Using 100 g/hr of propane gives 1000 hours of operation with a 100 kg propane store. Key market is the rapidly expanding decentralised power market.

Bosch Thermotechnology

was founded in 1886 and is located in Germany. It produces mainly fuel cell 'energy centres' for single- and two-family houses. The Bosch Thermotechnology division is responsible for all activities involving heating technology and hot-water solutions. The division has a number of major international and regional thermotechnology brands and supplies people with state-of-the-art technologies worldwide. They use for their products flat-tubular stack technology from the Japanese AISIN group (see entry in Asia section). Their main 'energy center' product is CERAPOWER: the system is based on the Aisin 700 W system and is currently tested in the frame of the European m-CHP demonstration project *ene.field*.

Table 1. Characteristics of Bosch Cerapower. [source www.bosch-thermotechnology.com]

ENERGY CENTRE	
Dimensions, WxHxD [mm]	1220x80x600
Weight [kg]	220
FUEL CELL	
Power output [W]	700
Thermal output [W]	700

Electrical efficiency [%]	45
Overall efficiency [%]	90



Figure 25. BOSCH's Cerapower energy center [source [www. www.bosch-thermotechnology.com](http://www.bosch-thermotechnology.com)]

Ceres Power

is located in the UK and was founded in May 2001 to commercialize the unique core materials technology developed at Imperial College during the 1990s. Today, Ceres Power develops micro-CHP SOFC systems for the residential sector and for energy security applications, basing their operations and technology centre in Crawley and fuel cell mass manufacturing facility in Horsham, Sussex. Ceres Power has built and developed relationships with key industry partners such as British Gas, Calor Gas and Bord Gáis.

The patented Ceres fuel cells are metal-supported (stainless-steel), allowing rapid start-up times and a great number of on/off cycles with little degradation. Their operating temperature range is 500-600°C, significantly lower than the cells designed with conventional materials which typically operate at around 800 °C. This is possible thanks to the metal support (allowing the use of extremely thin and active catalytic components) and by using a new generation of ceramic material known as CGO (cerium gadolinium oxide) instead of the industry standard YSZ (yttria-stabilised zirconia).

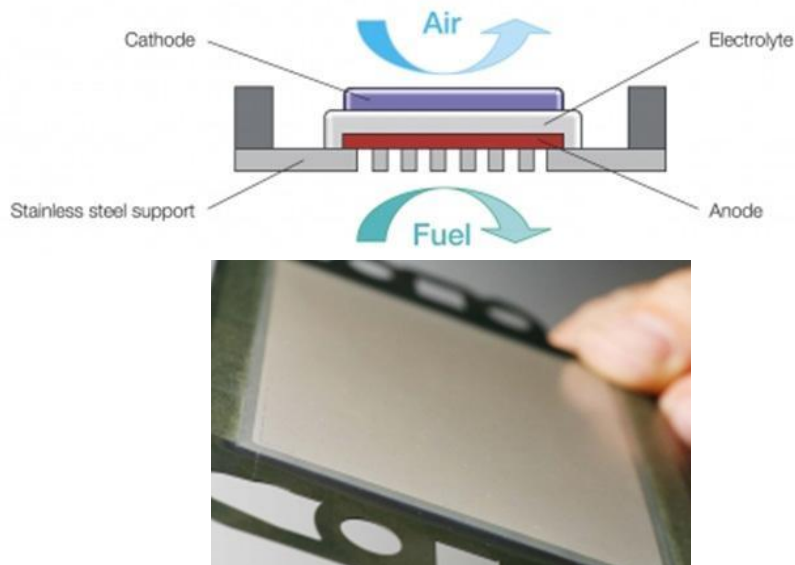

Figure 26. Detail of Ceres Power's single, metal-supported fuel cell, allowing extremely thin active layers and low temperature operation [source: Ceres Power, www.cerespower.com]

The company's first pre-commercial product is an integrated wall-mounted residential fuel cell combined heat and power (CHP) product. The compact product is designed to replace a conventional boiler, using the same natural gas, water and electrical connections and with similar installation and maintenance requirements.

These m-CHP units have showed degradation rates of approximately 1% per 1000 hours of operation. According to Ceres, the micro-CHP product has the potential to meet the overall commercial performance requirements supporting mass market deployment from 2018.

Under a new agreement, Ceres' partners British Gas (UK) and Itho-Daalderop (Netherlands) are to purchase 174 micro-CHP units for sale, installation and trial in UK and Dutch homes from 2014. Select customers will have the opportunity to purchase a Ceres micro-CHP unit with full service and maintenance package provided by British Gas in the UK and by Itho-Daalderop in the Netherlands.

Feedback from these trials will be used by Ceres to refine the product and validate performance and operability prior to mass volume launch in 2018. The trials will be part of the *ene.field* project, a large-scale demonstration of a thousand fuel cell micro-CHP products across Europe.

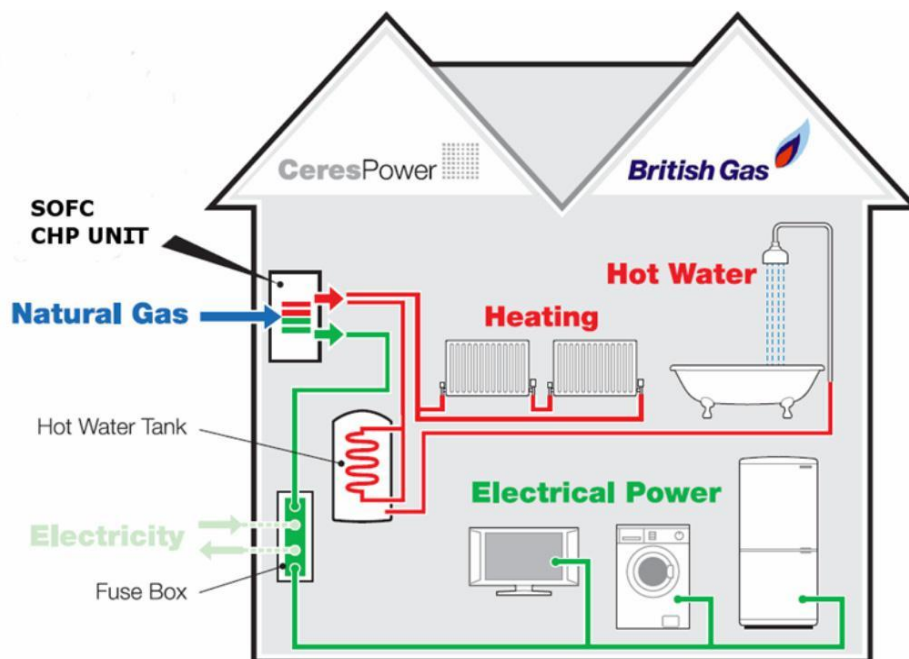

Figure 27. Ceres Power fuel cell integration concept in residential environment [source: Ceres Power, www.cerespower.com]

Convion Ltd.

was established in 2012 and in January 2013 the company took over Wärtsilä's fuel cell program and continued development and commercialization of products based on solid oxide fuel cell technology as an independent company. Convion Ltd. is a leading fuel cell system developer committed to commercializing solid oxide fuel cell (SOFC) systems in power range of 50-300kW for distributed power generation fuelled by natural gas or biogas. Convion shareholders include VNT Management and Wärtsilä. Convion aims to provide a complete power generation solution based on SOFC technology.



Figure 28. Convion's C50 product: a 50 kWe CHP generator with 53% electrical efficiency

The main figures of the Convion C50 fuel cell unit are shown in the table below.

Table 2. Characteristics of Convion C50 [source: Convion]

Performance	Targets
Net power output	58 kW (3x400-440V AC 50/60 Hz)
Energy efficiency (LHV) Electrical (net,AC) Total (exhaust 40 °C)	> 53% >80%
Heat recovery Exhaust gas flow Exhaust gas temperature	650 kg/h 222 °C
Emissions NO _x Particulates (PM10) CO ₂ (NG, nominal load) CO ₂ (with heat recovery)	< 2 ppm <0.09 mg/kWh 354 kg/MWh 234kg/MWh
Fuels	Natural gas, City gas, Biogas
Dimensions (LxWxH) Power unit Auxiliary equipment	3,5 x 1,9 x 2,3 m 2,4 x 0,6 x 2,2 m
Noise level	< 70 dB (A) at 1 m
Installation Ambient temperature	Indoor/outdoor -20 -+ 40 °C

Each Convion C50 module is a fully integrated and autonomously operable power unit. Installations of multiple parallel modules can form an on-site power plant of power output of several hundreds of kilowatts, securing critical loads and providing continuous power and heat generation as a back-bone generator of a local microgrid.

Elcogen

is located in Estonia and Finland and was established in 2001 in Estonia. Elcogen is a privately owned company which focuses on commercializing anode-supported SOFC cells and stack to open markets. Its cell technology is optimized for 600–700°C operating temperature with state-of-the-art cell performance proved both in fuel cell and electrolysis operation modes. The lifetime expectation of well over 20,000 hours for the unit cells combined with the low-cost manufacturing methods already implemented in cell production enhances the cost effectiveness of stack and system structures. Elcogen has been developing its cell and stack technologies closely with the Estonian and Finnish research institutes KBFi and VTT Technical Research Centre of Finland. It offers fuel cell stacks of 1 kW_{el} utilizing Elcogen unit cells. Elcogen SOFC stacks operate at temperatures between 600 and 700°C. They are based on a new generation of design focused on high efficiency, long lifetime, low cost materials and efficient, cost-effective mass manufacturing. The design is modular to enable its use in applications ranging from hundreds of watts to hundreds of kilowatts. The design is supported by long SOFC stack research as well as practical system knowledge from real-life applications.

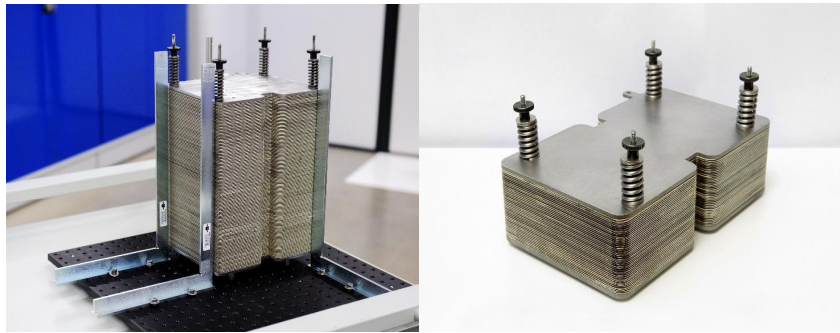

Figure 29. Left: E3000, 3kW stack; right: E1000, 1kW stack [source: www.elcogen.com]

The performance specifications of Elcogen stack E3000 and E1000 are presented in the table below.

Table 3. Characteristics of Elcogen stacks [source: Elcogen]

	E3000	E1000
Rated power [W]	3000	1000
Number of unit cells [pcs]	39	119
Maximum voltage (OCV,H ₂) [V]	47	141
Minimum voltage [V]	27	81
Nominal current [A]	30	30
Maximum current [A]	40	40
Air utilization	0,12-0,3	0,12-0,3
Maximum fuel utilization	0,7	0,7
Maximum degree of internal reforming	0,65	0,65
Maximum temperature[°C]	720	720
Maximum inlet temperature for air [°C]	580	580
Maximum temperature difference [°C]	100	100
Maximum working pressure [mbar]	50	50

Elcogen SOFC unit cells are designed to operate at lower temperatures (600–700°C) to facilitate use of cost-effective metals in stacks. The Elcogen manufacturing process enables the production of various forms of cell, circular or rectangular up to a maximum of 20x20 cm for a cell. The anode-supported cell

technology offers excellent efficiency and durability even at these lowered temperatures. Unit cells can be produced in different thicknesses, shapes or sizes and together with strict quality control specific customer requirements will be met.

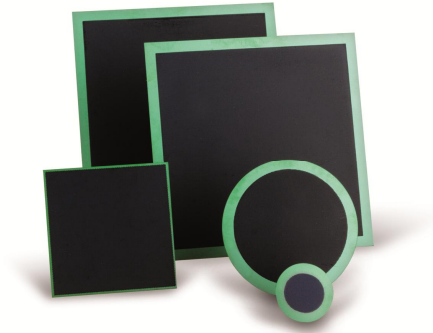

Figure 30. Elcogen's fuel cells. Cell show 5.5% degradation after 1000 h @ 60% fuel utilization and 650 °C operating temperature with a reformat mixture of 15% CH₄, 26% CO₂, 29% H₂, 30% H₂O [source: www.elcogen.com]

ElringKlinger AG

is a family-owned company founded in 1879, located in Germany. ElringKlinger AG has worldwide activities in the development and the supply of cylinder head gaskets as well as several other flat gaskets, housing modules and thermal shielding modules for engines, gear boxes and exhaust systems. EK is the only independent gasket manufacturer with global activities and supplies almost every European and American vehicle manufacturer as well as numerous Asian car and truck companies. With more than 6990 employees at 41 locations in Europe, America, Africa and Asia the ElringKlinger group generated a turnover of 1175 million € in the year 2013. ElringKlinger has been developing processes and producing components for planar SOFC fuel cell stacks since the year 2000. ElringKlinger started to produce SOFC stacks in the year 2004. Today a pilot line for stack assembly is established in the headquarters in Dettingen an der Erms. The stack concept is based on the use of anode substrate cells. ElringKlinger manufactures interconnectors for SOFCs with the help of high-precision, volume-production-capable tools and by applying closely intermeshed production processes.



Figure 31. ElringKlinger interconnector for SOFC [source: www.elringklinger.de]

Solid oxide fuel cells (SOFCs) are categorized as high-temperature fuel cells and can therefore be run on standard fuels such as natural gas or diesel. Wherever hydrocarbon-based fuels are available, this fuel cell technology can be deployed effectively in all those areas of application in which low consumption, noise and emission levels are an essential requirement. ElringKlinger supplies lightweight SOFC stacks as a central component for these applications; they can be easily integrated into customer systems (electrical output: 0.2–5 kW).



Figure 32. ElringKlinger SOFC stack with power output 0.5 kW [source: www.elringklinger.de]

Haldor Topsøe AS

Mr. Haldor Topsøe founded the company on April 10, 1940. Haldor Topsøe delivers a wide range of catalysts and process technology that is essential for producing clean fuels from crude oil and waste, removing harmful emissions from power plants and vehicle exhaust, and raising the efficiency of industrial processes.

In 2004 Topsøe Fuel Cell (TOFC) was established as a subsidiary owned by the Haldor Topsøe AS and focused on the development of residential micro-CHP and auxiliary power units with SOFC planar anode-supported technology. Cell manufacture was established in a 1400 m² building based on semi-automated, modular and scalable processes. The facility output capacity exceeds 5 MW per year. In 2014, TOFC was closed and the activities transferred back to the mother company. As part of this closure, the development of its SOFC technology was put on hold and focus was instead set on the development of selected applications in solid oxide electrolysis cell development (SOEC).

HTAS has introduced a SOEC system for the production of CO from CO₂ called eCOs plant. Further activities comprise upgrading of biogas to natural gas quality using SOEC.



Figure 33. Haldor Topsøe stacks for solid oxide electrolysis [source: <http://www.topsoe.com/products/ecos-containerized-co-generation-plants>]

Kerafol GmbH

was founded in 1985 in Germany. The company Kerafol® – Keramische Folien GmbH is the specialist for ceramic foils and a major manufacturer of technical ceramics. At their production site in Eschenbach in der Oberpfalz (Bavaria), products for thermal management, porous ceramic filter materials for fuel cells, ceramic substrates and ceramic foils are fabricated. These are used in a wide variety of applications, such as microelectronics, thermal management, filtration, sensor technology, SOFC fuel cells and LTCC technology. Since 1990, Kerafol® is involved in the field of the SOFC technology. In addition to the key components, being electrolyte substrates and electrolyte supported cells, Kerafol® also produces glass sealing tapes for stacks. Kerafol® offers both electrolyte substrates and electrolyte supported cells. In the electrolyte supported cell the electrolyte is the bearing component. The electrolyte separates the anode and cathode spatially from each other and usually consists of zirconia. At operation temperatures between 750 °C to 950 °C zirconia is a good oxygen ion conductor when doped with various metal oxides. Important factors for producing electrolyte tape and the choice of the doping metal oxide are the oxygen ion conductivity, the mechanical stability, the long term stability, gas tightness, and planarity. Kerafol® offers partially stabilized variations with high mechanical stability, fully stabilized zirconia with higher ionic conductivity, and a mixed version, which combines both properties.

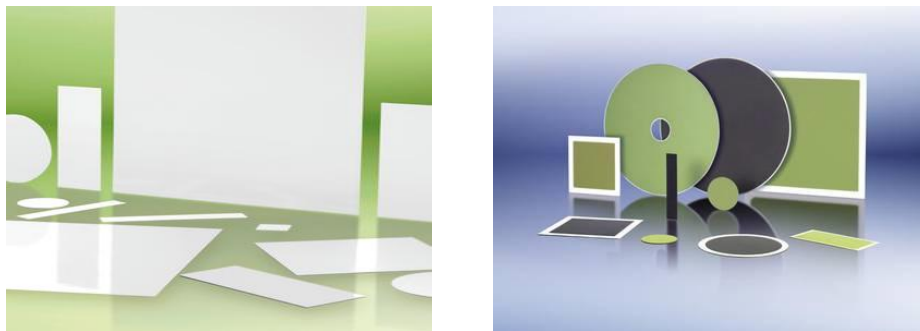

Figure 34. Various type of electrolyte substrates (left) and electrolyte-supported cells (right) [source: www.Kerafol.com]

Kerafol's electrolyte supported cells have a high planarity and are optimized for use in SOFC-stacks. Highly efficient electrodes with low polarization resistances have been developed. The robustness of the cells has been proven by several long term tests, by thermal cycles, and by oxidation/reduction tests. Kerafol also developed the cell type KeraCell III, which is based on a LSCF oxygen electrode.

Hexis/Viesmann

was created in 1997 as a venture division of Swiss engineering and manufacturing firm Sulzer and became independent in 2006. One year later they created the subsidiary company in Germany, Hexis. In 2016, Hexis was taken over 100% by Viesmann, the multinational boiler manufacturing company.

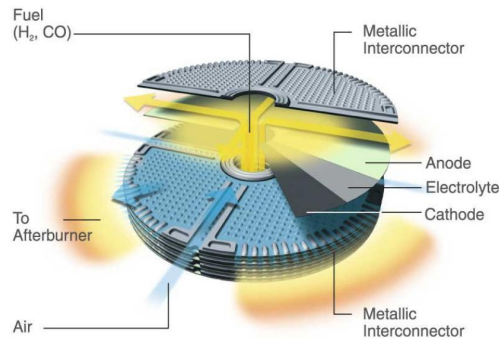

Figure 35. Working principles of a Hexis fuel cell. [source: Hexis, www.fuelcellmarkets.com]

Hexis develops SOFC-based CHP units for stationary applications with electrical power requirements below 10 kW. The company develops planar SOFC technology, where the cells have a circular design. The fuel enters the anode part of the cell through the centre of the disc, flowing radially outwards. The preheated air follows the same path on the cathode side.

Their commercial product is 'Galileo 1000N', which uses a stack module made up of approximately 60 cells, and can be fed either with natural gas or bio-methane, as the system integrates a catalytic partial oxidation (CPOX) reactor. The nominal electrical power output is 1 kW (AC), and the thermal power output is 2 kW, with an electrical efficiency of up to 35% and maximum overall efficiency of 95% (LHV). Galileo 1000N also incorporates a 20 kW auxiliary burner to complete the supply of thermal on-demand requirements of a house or small apartment building. The commercial unit, geared towards end-consumers, is available since 2013.

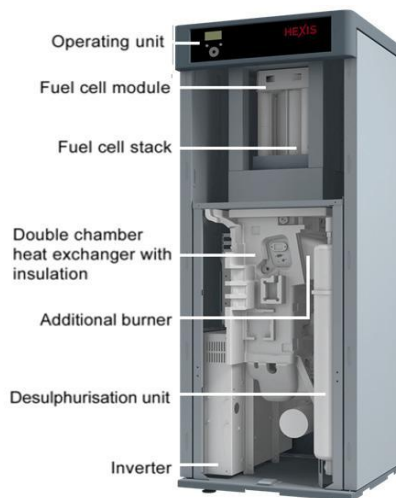

Figure 36. The Hexis Galileo 1000N m-CHP model [source: Hexis, www.hexis.com]

mPower GmbH

is a Dresden-based company formed in 2015 to commercialise the SOFC stacks developed by Fraunhofer IKTS & Plansee (see entry in Europe section). mPower has a world-wide license to manufacture, market and service the stacks for commercial applications.

mPower GmbH is a startup of h2e Power Systems Inc. (see entry in Asia section) which is developing a complete 1kW, 2kW, 5kW & 10kW fuel cell power generators for stationary power applications. Using h2e's wide network and domain expertise in the food value chain, mPower is developing hotbox and stack solutions that will help build fuel cell systems for the food value chain all over the world. mPower GmbH is focused on providing extended lifetime (currently 20.000 h demonstrated), ease of

integrating the stacks within the system and to bring down the costs to a level that will enable fuel cell systems to become commercially viable. Stacks with cumulative power output of more than 300 kW have been sold to commercial customers and the company is gearing up to develop solutions for various industry verticals in USA, Europe & India.

Table 4. Characteristics of commercial MK35x stacks [source: mPower GmbH]

Available Power Output Range in W	250 to 1200
Weight in kg	3.3 to 13.6
Operating Temperature in °C	780 to 860
System Compatibility	Compatible to partial oxidation, steam and auto-thermal reformers
Internal Reforming of CH ₄ in %	up to 32
Fuel utilization in %	up to 85

mPower’s MK35x stacks are already being used in commercial stationary fuel cell systems for decentralised power generation with multi-fuel compatibility. The stacks are known for their robustness, reliability & efficiency. mPower currently manufactures fuel cell stacks of different size for various stationary applications with the typical characteristics shown in the table below.

The company works closely together with Fraunhofer IKTS to design HotBox solutions, with which it can offer along with the stacks and stack modules for systems in the power range from 1kW to 50kW.



- Reliability and Design Simplicity
- Innovative & Solution Based Approach
- Cost Reduction & Affordability
- Global Industry Standard
- Frugal Engineering
- Operational Efficiency

Figure 37. mPower stacks and their key characteristics [source: mPower GmbH]

New enerday GmbH

originates in the former fuel cell development department of Webasto AG in Neubrandenburg, founded in 2010 as an independent company to continue the development of innovative SOFC-based fuel cell systems with a special focus on highly compact systems with ratings of up to 1000 watts. New Enerday is a company of the ElringKlinger Group. The principal product of New Enerday is presented in the figure below.



Figure 38. Fuel Cell System EN 300/500 with electric power 150-500 W, voltage 24-28 V DC, electric efficiency (net) 30–35% [source: www.new-enerday.com]

Plansee SE

was founded in 1921 and it is located in Austria. The Plansee Group is entirely focused on producing, processing and marketing the refractory metals molybdenum and tungsten. Plansee High Performance Materials is the world's leading manufacturer of products made of molybdenum, tungsten, tantalum, niobium and chromium – from powder production through powder-metallurgical processes to the customer-specific processing and recycling of these materials. The materials are used by customers in advanced industries and are key to today's and tomorrow's high-tech products. Important growth drivers include consumer electronics, coating technology, medical engineering and the semiconductor industry. The automotive sector, the aerospace industry, mechanical engineering and the construction sector also turn to the Plansee Group for expertise and materials solutions. Plansee supplies chromium-based interconnects for SOFC fuel cells. These provide the electrical and thermal connection between the fuel cell's anode and cathode and distribute fuel gas and air in the system. Using their powder metallurgical production process, they can manufacture near-net shape interconnects.



Figure 39. Plansee CFY interconnector for SOFC [source: www.Plansee.com]

With a mix of 95% chromium and 5% iron, Plansee's CFY can adjust the interconnect's coefficient of thermal expansion to match that of the electrolyte in the fuel cell. The electrochemical reaction in the fuel cell produces a lot of heat. The temperature can rise as high as 850°C. At the same time, the surfaces of the interconnects are exposed on one side to the oxygen present in the air, while the opposite side has to withstand high hydrogen concentrations. For this type of interconnects, that's not a problem. With a chromium content of 95%, their properties and geometry are unaffected. Another Plansee product are their metal-supported cells for mobile applications. These cells supply low-emission electrical power to trucks, mobile homes and yachts quietly and efficiently. With their short

start-up time, low weight and long service life which can tolerate a large number of on-off cycles, SOFC fuel cells are able to meet the exacting requirements involved in mobile applications.

Plansee uses a powder metallurgical process involving an Fe-26% Cr alloy to manufacture both the porous support for the electrochemically active cell and the interconnects themselves.



Figure 40. Plansee metal-supported cell form mobile applications [source: www.Plansee.com]

SOLIDpower SpA

(SOFCpower SpA before January 2015) is an Italian high-tech company based in Mezzolombardo, Trentino founded in 2006, by carving out the SOFC activities started in 2002 within the Eurocoating – Turbocoating Group, a privately-held group active in the fields of coatings and processes for gas turbines, machinery and biotechnology. In early 2007, SOLIDpower acquired 100% of HTceramix SA, a spin-off of the Swiss Federal Institute of Technology in Lausanne (EPFL). In 2015 it acquired in Heinsberg, Germany, the business and employees of Ceramic Fuel Cells GmbH (CFC) after the Australian parent company, Ceramic Fuel Cells Ltd, ceased activities.

SOLIDpower specializes in development, manufacturing and commercialisation of SOFC technology and systems for stationary applications including micro-cogeneration and remote power, SOFC testing and engineering services, SOFC system integration and high-temperature electrochemical membrane reactors. Over 750 SOLIDpower micro-CHP systems have already been sold globally and contracts with utilities for further micro-CHP deployment are in place.

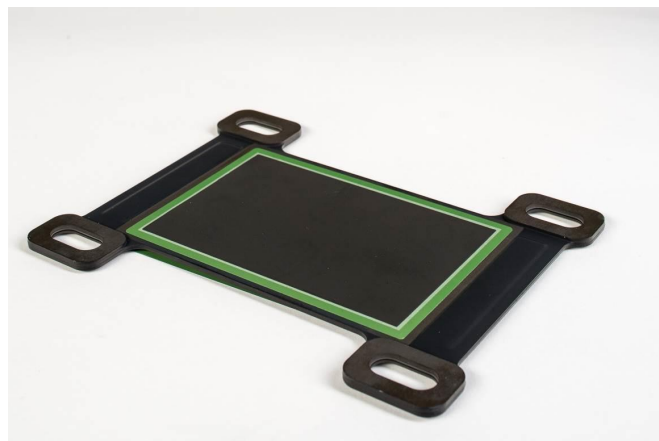

Figure 41. SOLIDpower's single planar cell unit for stacking

SOLIDpower commercializes two highly efficient products for distributed cogeneration, both using natural gas from the grid:

- BlueGEN, which is the most efficient small-scale generator in the world, generates continuous 1.5kW_e electric power at 60% efficiency (plus 0.6kW_{th} for 85% overall efficiency). With an annual

production of 13.000 kWh of electricity, it is appropriate for small commercial applications and is commercially available in various European markets.

- EnGEN 2500, a CE-certified m-CHP system with a nominal electrical output of 2,5 kW and 50% electric efficiency, which targets multi-family houses and commercial applications, even though larger generation units in MW-size can be realized by combining several modules. The wide range of modulation [30–100%] guarantees operation according to the user's actual electricity and heating needs. Furthermore it can be combined with other power/heat generators from renewable sources (wind, solar) or heat pumps, as well as electric storage or UPS systems. Heat created in the generation process also provides up to 200 litres of hot water each day, which takes the overall efficiency to 90%. This can save up to 4 tonnes of CO₂ emissions per year.



Figure 42. Integration of individual SOLIDpower cells in the 1 kWe BlueGEN (centre), and the 2.5 kWe EnGEN 2500 (right) [source: www.solidpower.it]

Sunfire-Staxera

is a joint venture between Webasto AG and H.C. Starck GmbH and is located in Dresden, Germany. Energy-related German company Sunfire and SOFC developer Staxera merged in 2011 as equal partners creating a brand-new company, although the Staxera brand has been retained. Sunfire is a manufacturer and developer of clean and efficient solutions for decentralized power generation and energy storage. Sunfire's high-temperature fuel cells (SOFC) efficiently generate electrical power and heat according to the principle of cogeneration (CHP). They allow on-demand generation for residential and industrial applications as well as off-grid power supply in remote areas. Sunfire uses the Staxera stack technology, based on the cells shown in the figure below.

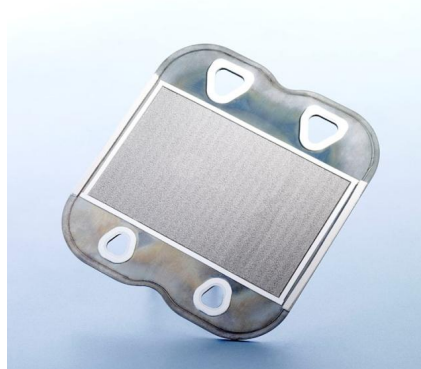

Figure 43. Sunfire single ESC cell design [source: www.sunfire.de]

Staxera-sunfire has commercialized products up to 4.5 kW, based on their Mk200 stack. The robust, cost-optimized design of the Staxera Mk200 stack makes use of ferritic bipolar plates and electrolyte-supported cells (ESC). Low pressure loss and specially optimized fuel gas distribution mean that the Staxera Mk200 stack can be used to realize top-quality systems with low parasitic losses and therefore high levels of efficiency. The stack is designed to operate in combination with a wide range of fuel gases (e.g. as part of catalytic partial oxidation (CPOX) or steam reforming (SR) systems), and is characterized by excellent reliability in terms of both thermal and redox cycles. Stack size (i.e. the number of levels or cells) can be tailored to client requirements. The stack directly heated by anodic and cathodic gases. The gases are preheated to 400 °C. The thermal energy generated by chemical reactions within the stack further increases the temperature, up to the operating point of 850°C.



Figure 44. Staxera-Sunfire's 116 x 168 x 182 mm³ cell stack, Fuel utilization 75 %, rated power output 600 W, operating voltage 19.5 V, weight < 14 kg. Performance at specified fuel compositions: 1: H₂/N₂ 40%/60%, process efficiency (reformer and stack, LHV) 40% power output at operating Voltage 650 W; 2: steam reformat (S/C=2) power output at operating Voltage 550 W, process efficiency (reformer and stack, LHV) 48% [source: www.sunfire.de]

Zegpower

was established in 2008 as a Joint Venture between the two Norwegian research institutes Institute for Energy Technology (IFE, Kjeller) and Christian Michelsen Research AS (CMR; Bergen). Its Cooperation Partners are: Statoil Financing and technology development, Norges Forskningsråd (Financing of R&D projects), Innovasjon Norge (Financing of business development and technology development, Miljøteknologiordningen), Gassnova (Financing of technology development and demonstration), IFE (Hydrogen production); Reactor technology and CO₂ sorbents, Hynor Lillestrøm AS (Test facilities), Kjeller Innovasjon (Company establishment), Bergen Teknologioverføring (Company establishment). The objective is to design, build and verify the patented ZEG® technology for commercial power plants of increasing size and complexity. Main deliverables are concepts and detailed designs of ZEG® plants for selected applications of different sizes, and complete small scale plants. This technology is characterized by:

- High overall efficiency (more than 75%), including ~ 100% CO₂ capture and compression of CO₂ to 110 bar;
- All types of carbon based fuels can be used; natural gas, biogas, gasified biomass, coal, tar or oil
- Product compositions can be varied (within design limits) depending on market demand and customer need of electricity, hydrogen and heat;
- Possibility of standalone production;
- Applications and scale from small scale distributed plants based on biogas to industrial scale power plants based on natural gas.

ZEG-technology is a hybrid technology for highly efficient co-production of electric power and hydrogen from hydrocarbon fuels with integrated CO₂ capture. High total efficiency is achieved through thermal integration of high temperature fuel cells (SOFC – Solid Oxide Fuel Cells) and a reactor system for hydrogen production (SER – Sorption Enhanced Reforming).

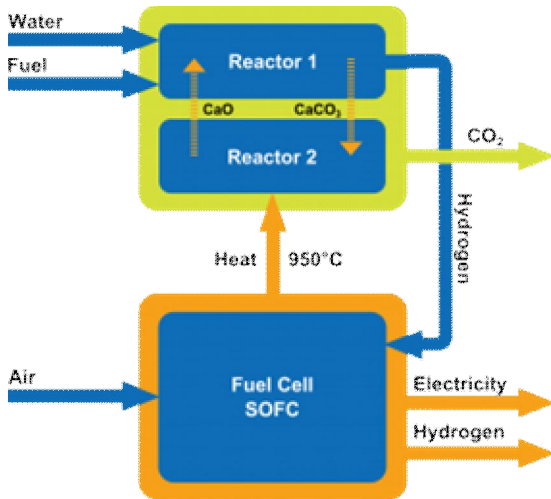

Figure 45. The principle of ZEG technology (left) and the 50 kW BioZEG plant at Hynor Lillestrøm, Akershus Energy Park [source: www.zegpower.no]

The SOFC stacks produce electricity and high temperature waste heat. The waste heat is used to produce hydrogen in a modified reforming reaction where a solid (CaO – calcium oxide) is added, that captures CO₂ as an integrated part of the process. The CO₂ is delivered pressurized from the plant ready for industrial use or storage. The ZEG-technology enables conversion of hydrocarbons into energy with a very high efficiency, from 70 to more than 80%, depending on the plant size and design. In-site production of hydrogen from biomass will, when used for transportation, in addition to reducing CO₂ emissions, also reduce the need for transport of hydrogen to a refuelling station. CO₂ capture is an integrated part of the ZEG-technology, and it is advantageous for the total energy yield that the CO₂ is captured. If bio CO₂ is emitted this is seen as climate-neutral, and if CO₂ is used or sequestered (BioCCS) this will represent a positive climate contribution. Work is ongoing to identify industrial applications and customers that require both hydrogen and electric power and with integrated systems where carbon capture and sequestration (CCS) can be a part of a larger process plant.

Asia

Aisin Seiki

was established in 1965 with head office in Aichi, Japan. It comprises 181 consolidated subsidiaries, 66 of which in Japan and 115 overseas, and its businesses span the manufacture and sales of automotive parts (drivetrain, body, brake and chassis, engine, information technology-related), lifestyle- and energy-related products (mCHP, gas heat pump, sewing machines, beds, etc.), and wellness-related products. In terms of SOFC technology, they produce an innovative concept of flat sheet and tube cell which operate at between 700 and 750°C. Japan has a major deployment campaign of micro-CHP systems ongoing, named 'ENE-FARM', based on both PEFC (polymer electrolyte fuel cell) and SOFC technology. Already well over 140,000 ENE-FARMS have been installed since 2009. Currently AISIN is the only company supplying stacks to the systems based on SOFC, though competitors TOTO and NGK will introduce their stacks to the ENE-FARM programme soon.

In close collaboration with Osaka Gas, Kyocera and Chofu, AISIN's 'ENE-Farm Type S', for residential fuel cell CHP fed with utility natural gas, was launched in 2014, achieving a power generation efficiency of 46.5% (LHV), and an overall efficiency of 90% (LHV). The SOFC system includes a heating unit, to optimally utilize the high-temperature heat exhausted during power generation, which fills a small storage tank of 90 litres with hot water, as well as a high-efficiency latent heat recovery type unit for the back-up boiler. The micro-CHP system is environmentally and economically optimized, and avoids annual CO₂ emissions by approximately 1.9 tons while also reducing annual energy costs by about \$ 909 compared to ordinary gas-powered hot-water supply and heating units. Within the co-development agreement, Kyocera produces the stack, Aisin the generation units with the cell stack incorporated into it, Chofu the hot-water supply and heating unit using exhausted heat. Osaka Gas commenced sales of the system in 2014 (only to the Japanese market) and the standard price of the system has reduced considerably since then (see Table 5).

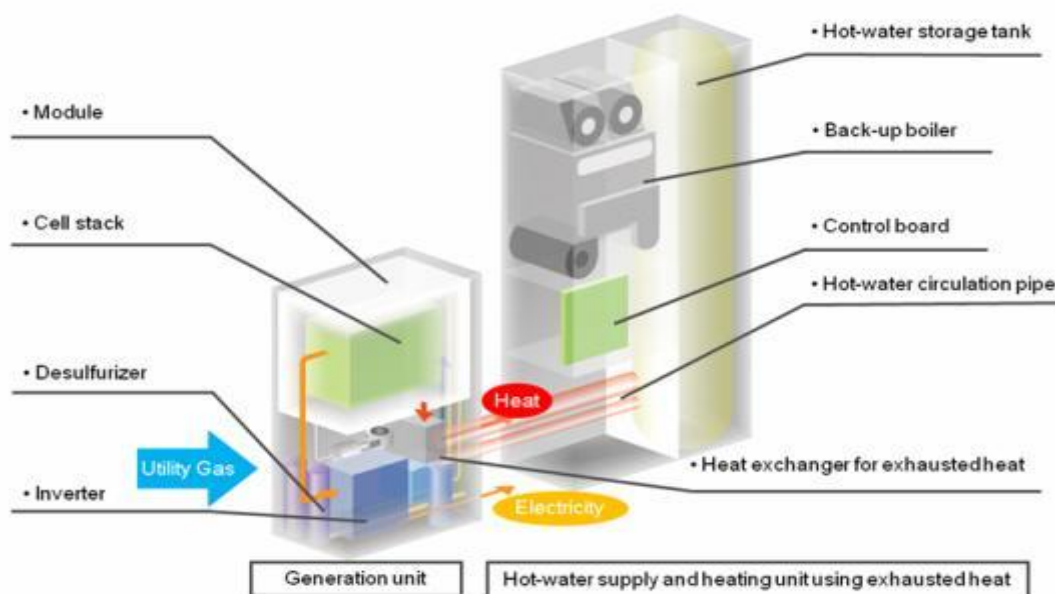

Figure 46. Schematic of an Ene Farm type S m-CHP system [source www.aisingroup.com]

Table 5. ENE-Farm Type S (SOFC-based) for residential fuel cell CHP specifications [source: Kyocera, Nippon Oil & Energy, www.global.kyocera.com]

ENE-FARM RESIDENTIAL FUEL CELL CHP		
Selling date: April 27, 2012		
Basic Function	Rated power output	700 W
	Power output range	5 ~ 700 W
	Power generation efficiency	46.5% (LHV)
	Overall efficiency	90% (LHV)
	Operation temperature range	-10 ~ 43 °C
	Start-up time	120 ~ 180 min
	Operation time	24 hrs continuous
	Hot-water tank capacity	90 litres
	Hot-Water Temperature	~ 70 °C
	Installation	outdoor
	Voltage	100 V (50/60Hz)
Dimensions	Power Generating Unit	600 W × 935 H × 335 D (mm)
	Hot-Water Supply and Heating Unit using Exhausted Heat	740 W × 1,760 H × 310 D (mm)
Weight	Power Generating Unit	96 kg
	Hot-Water storage Unit	94kg (188kg in operation)
Installation Space		Approx. 1.9 m ² (Approx. 1.6 m ² with side exhaust gas cover)
Standard Price (incl. taxes and excl. installation cost)		¥2,322,000

Chaozhou Three-Circle Co., Ltd. (CCTC)

was established in 1970 in Chaozhou, China. CCTC develops material, manufactures products and equipment, and carries out research and development as well. The application of its hi-tech ceramic products has extended to telecommunication, electronics, machinery, environmental protection, new energy biology and fashion etc. Previously including Ceramic Fuel Cell Limited (CFCL), CCTC branches include electrical, electronic, optical, medical, and structural ceramic manufacturer. Its principal products are anode supported SOFC cells, SOFC electrolyte membranes and Stack.



Figure 47. CCTC anode supported SOFC cells (left), SOFC electrolyte membranes (right) [source: www.cctc.cc]



Figure 48. C1 stack, 1 kW power stack efficiency degradation < 0,2%/khrs at BlueGen system Stack DC electrical efficiency > 65% at BlueGen system.

G-cell Technology Co., LTD

was founded in 2013. It is established in Hefei Anhui, China. The company mission relies on the relevant technology of SOFC to provide energy efficient, environmental protection solutions and applications. It produces distributed power stations and standby power supply and application of SOFC in environmental protection and emission reduction, through for example Experimental SOFC stacks and 1 kW power station. In this company Air Brazing technology is used to improve the sealing ability between the SOFC cell and metal support, and to achieve the SOFC stack by combination of series and parallel connections.

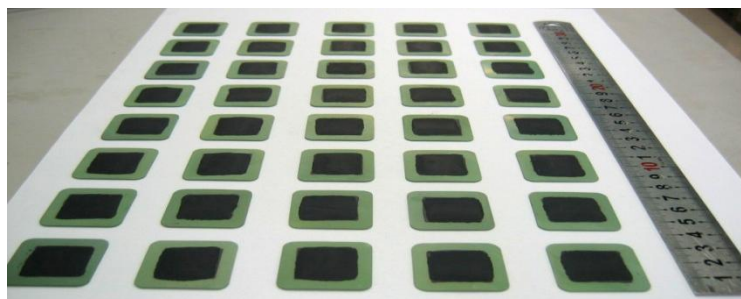

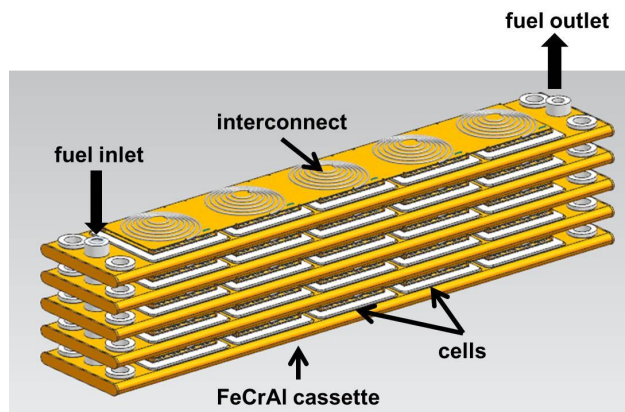

Figure 49. G-cell Technology SOFC cells and stack [source: www.Gcell.com]



Figure 50. The G-cell C1 stack provides 24V, power output 1kW [source: www.Gcell.com]

Gas Authority of India Ltd./Bloom Energy.

In India, the Bloom Energy Servers will be used to produce electricity using Natural Gas as fuel to meet base load requirements. These will be mainly installed at locations where natural gas pipelines are available and electric power is required. The state-of-the-art solid oxide fuel cell (SOFC) technology of Bloom Energy systems headquartered in Sunnyvale, California with operations in Newark, Delaware, Bengaluru and Mumbai and Gas Authority of India Limited (GAIL) are expected to generate power in an uninterrupted, efficient, continuous and silent manner. Gail is already supplying natural gas for A 2.5 MW system at the location of Intel in Bangalore.

h2e Power Systems Inc.

located in Pune, India, and New York, U.S.A., was founded in 2012. H2e power systems is a part of the Mayur consortium. The company is internationally well connected and has contacts with several production plants and trading companies in the fields of residential construction, energy engineering, agriculture and waste management. h2e Power Systems aims at producing fuel cell systems in India and establishing integrated efficient energy supply solutions in order to allow for a cost-efficient, reliable and environmentally friendly power supply.

Fraunhofer IKTS and h2e Power Systems Inc. (part of India's Mayur Group) have set up a joint venture for the development and distribution of cost-efficient fuel cell devices. The know-how and technology transfer is initiated in order to facilitate local device production and commercialization in India by h2e Power Systems Inc. from 2016. In 2015, India's first ever solid oxide fuel cell system, (two prototype

systems) developed by Fraunhofer IKTS was commissioned by h2e Power Systems Inc. During operation with natural gas, the prototype reached the intended key performance indicators with an electrical power production between 300 and 1000 W(el) and an electrical net efficiency around 35 to 40%.

h2e's product range is aimed at various market segments (from the company website):

- Commercial: h2e can provide 1–10 kWe fuel cell generators for small commercials, hospitals, office buildings, schools/colleges, telecom towers & small/medium enterprises & small industries.
- Residential: h2e can provide 0.5–5 kWe fuel cell generators for apartments, Villas, high end homes, small, medium & rural households.
- Agricultural: h2e can provide 1–3 kWe fuel cell generators for food processing, cold storages, green house and farms.



Figure 51. Artist's impression of a h2e Power Generator

Huatsing Jingkun New Energy Technology Co., Ltd

was created by an academician of the Chinese Academy of Engineering Peng Suping, chief scientist of the National 973 Project, Professor Han Minfang, and others, in February 2010. Huatsing New Energy is a high-tech enterprise integrating scientific research, new technology development, and high-tech production. It has independent intellectual property rights, whose main businesses include high-efficiency clean new energy technologies, new materials technology products, environmental protection products and engineering, and the design, manufacturing and services of related equipment. The specific products include SOFC core components and key materials, SOFC power generation systems, fuel cell test systems, engineering materials products, thermal equipment, environmental protection engineering and related services.

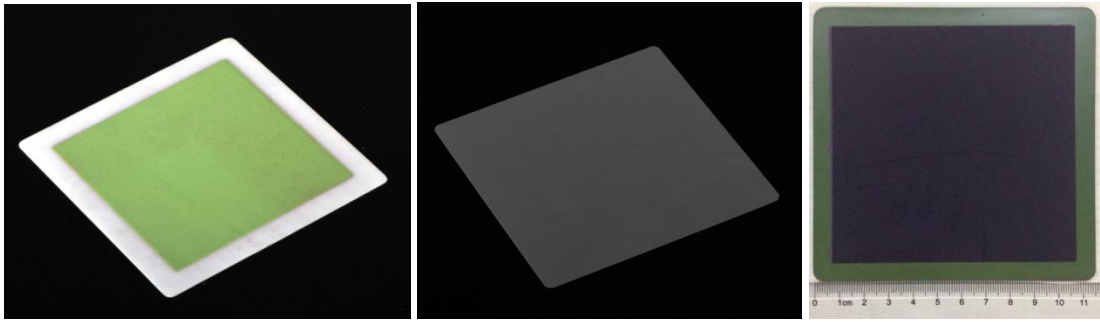

Figure 52. Huatsing New Energy SOFC cells. Right: Electrolyte Supported Cell, centre Anode Supported Cell, left Tri-layer YSZ-based cell [source: en.huatsing-power.com]

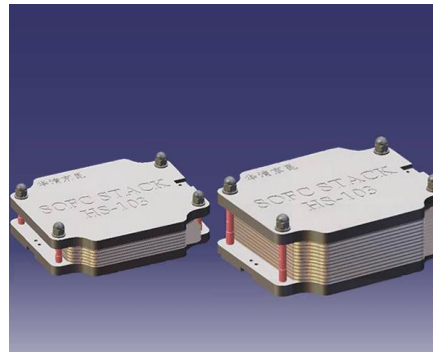

Figure 53. HS-103 type power stack 2.5–5kW, provides a voltage of 16.8–34 V [source: en.huatsing-power.com]

Mitsubishi-Hitachi Heavy Industries (MHI)

was established in 1914 and is a multinational engineering, electrical equipment and electronics company headquartered in Tokyo, Japan.

MHI has been involved in the field of high-temperature fuel cells since the 1990s. In 1998, in cooperation with Electric Power Development Co. they produced a pressurized SOFC module which operated for 7000 hours and had a maximum power output of 21 kW. In 2004 MHI succeeded in the first domestic operation of a combined-cycle system combining SOFC and a micro gas turbine, with a confirmed generation of 75 kW at Mitsubishi's Nagasaki Shipyard & Machinery Works. As a result of its performance, in 2007 they decided to scale up the system to 200 kW, with a maximum power output of 229 kW and an electric efficiency of 52%. In 2009, MHI achieved an operation time of 3000 hours with this system, the longest so far in Japan. From this point forward, MHI has continued to increase the reliability and to further reduce the unit size, tying these qualities to the practical development of utility-size generation systems. Indeed, MHI is demonstrating a 250 kW coupled SOFC-microturbine in a triple combined cycle system which also generates steam to power a steam turbine, and which is currently operational at Kyushu Ito University.



Figure 54. Mitsubishi's 250 kW coupled SOFC-microturbine system [source: NEDO]

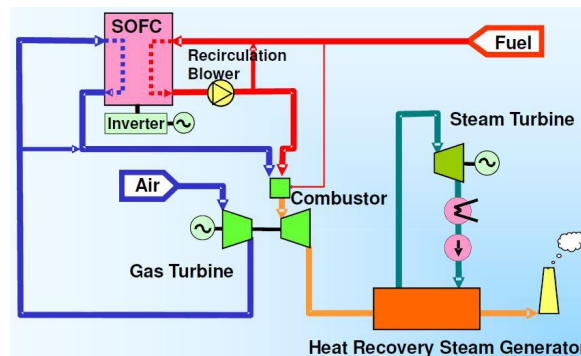

Figure 55. Mitsubishi is developing a SOFC-turbine triple combined cycle system [source: MHI, Proceedings of Fuel Cell Seminar 2011]

Mitsubishi uses a mono-block layer built (MOLB) type of cell. This is a planar cell constructed of a ceramic substrate made up of anode, electrolyte and cathode (so-called generation membrane), dimpled in three dimensions and manufactured on an uneven surface and an interconnector that connects the generation membranes in series, and acts as a gas seal on the cell end.

MHI presented the first MOLB type SOFC cogeneration system in Japan at the World Fair held in Aichi in 2005, with a planar SOFC achieving a maximum output of 30 kilowatt through 100 percent internal re-forming for the first time. Currently, the target is to further improve the fuel cell output, and research is proceeding.

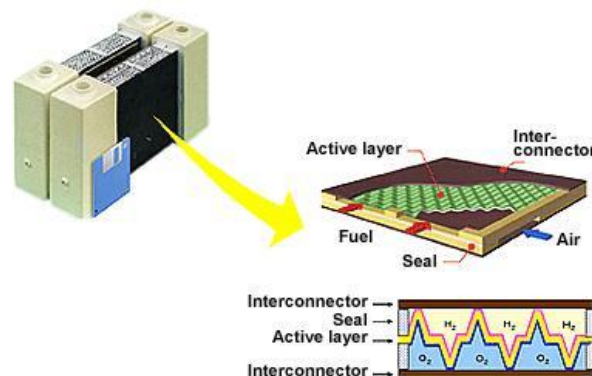

Figure 56. MOLB Type SOFC Structural Diagram [source: MHI, www.mhi.co.jp/en]

MiCo

was founded in 1996. It is associated with KoMico, MiCoBioMed. Core competences of MiCo has been manufacturing various ceramic parts with their core technologies achieved through continuous research & development on high-functional parts over the years. They produce SOFC materials, planar cells and micro-tubular cells.



Figure 57. Anode Supported Cell, LSM (5 cm ×5 cm), Anode Supported Micro-tubular Cell, LSM (3Φ×54 Φ) and the stack QubePower-200 [source:www.mico.kr]

POSCO Energy

founded in 1969 as Kyung-In Energy Company and having joined the POSCO FAMILY in 2005, is a comprehensive energy provider engaged in four key energy business areas: Power generation, Renewable energy, Fuel cell, and Resource development. Headquarters of POSCO Energy is in Seoul City, South Korea. Fuel Cell Division of POSCO Energy is located at Pohang City. It produces also stationary application with MCFC and building applications with SOFC. POSCO ENERGY produces various fuel cell products ranging from 100kW to 2.5MW to provide customers with a wide range of fuel cell products to suit their purposes. It currently supplies 100kW, 300kW, and 2.5MW fuel cell products and is also developing other products applicable to various areas, as well as the next-generation SOFC technology.



Figure 58. Next-generation SOFC product of 300 kW [source: www.poscoenergy.com]

SOFCMAN Energy Technology Co., Ltd.

was founded in 2014 and is established in Ningbo, China. SOFCMAN are focused on the commercialization of proprietary SOFC technology into a growing international market.



Figure 59. SOFC electrolyte supported cells and the SOFCMAN-ASC 60 Cell stack 601 with 10 cm*10 cm cells, maximum output power: 1600–2000W at 750°C, operation power :1400–1600W at 750°C, 0.70–0.75V



Figure 60. SOFCMAN-ASC 30-cell Stack-2kW in this product the cell area is enlarged from 10cmX10cm to 14cmX14cm, SOFCMAN 30-cell stack (14cmX14cmX8cm) with double area showed a peak power of 2.6kW and current of 128A at 750°C. Under a self-sustained condition, the stack power reached 2.2kW, at a current of 90A, average cell voltage of 0.8V, fuel utilization of 68%, and electric efficiency of 44%. The volumetric power density is over 1.4kW/L.

Contact List for SOFC Deployment

North America

Atrex Energy (USA)



www.atrexenergy.com

Bloom Energy (USA)



www.bloomenergy.com

Ceramatec (USA)



www.ceramatec.com

Delphi (USA)



www.delphi.com

FuelCell Energy (USA)



www.fuelcellenergy.com

LG Fuel Cell Systems (USA)



no website

MSRI (USA)



www.msrihome.com

Protonex (USA)



www.protonex.com

Ultra USSI (USA)



www.ultra-ussi.com

Nexceris (USA)



www.nexceris.com

Europe

Adelan (United Kingdom)



www.adelan.co.uk

Bosch Thermotechnology (Germany)



www.bosch-thermotechnology.com

Ceres Power (United Kingdom)



www.cerespower.com

Convion (Finland)



www.convion.fi

Elcogen (Estonia, Finland)



www.elcogen.com

Erling Klinger (Germany)



www.erlingklinger.com

Haldor Topsøe (Denmark)



www.topsoe.com

Kerafol (Germany)



www.kerafol.com

Hexis/Viesmann (Germany)



www.hexis.com

New enerday (Germany)



www.newenerday.com

Plansee (Germany)



www.plansee.com

SolidPower (Italy)



www.solidpower.com

Sunfire/Staxera (Germany)



www.sunfire.de

ZEG Power (Norway)



www.zegpower.com

Asia

Aisin-Seiki (Japan)



www.aisin.co.jp

Chaozhou Three-Circle (China)



www.cctc.cc

G-cell Technology (China)



www.gcell.com

Gas Authority of India (India)



GAIL (India) Limited

www.gailonline.com

h2e Power Systems (India)



www.h2epower.net

Huatsing Jingkun New Energy Technology (China)



www.huatsing-power.com

Mitsubishi-Hitachi Heavy Industries (Japan)



www.mhi.com

MiCo (China)



www.mico.kr

POSCO Energy (South Korea)



www.poscoenergy.com

SOFCMAN Energy Technology (China)



www.sofc.com.cn

